



# ILLUSTRATIONS from the TABERNACLE

a collection of  
drawings depicting  
the activities of  
Leviticus 8, 9 & 16



by  
Brother John Laursen  
Clearwater, Florida

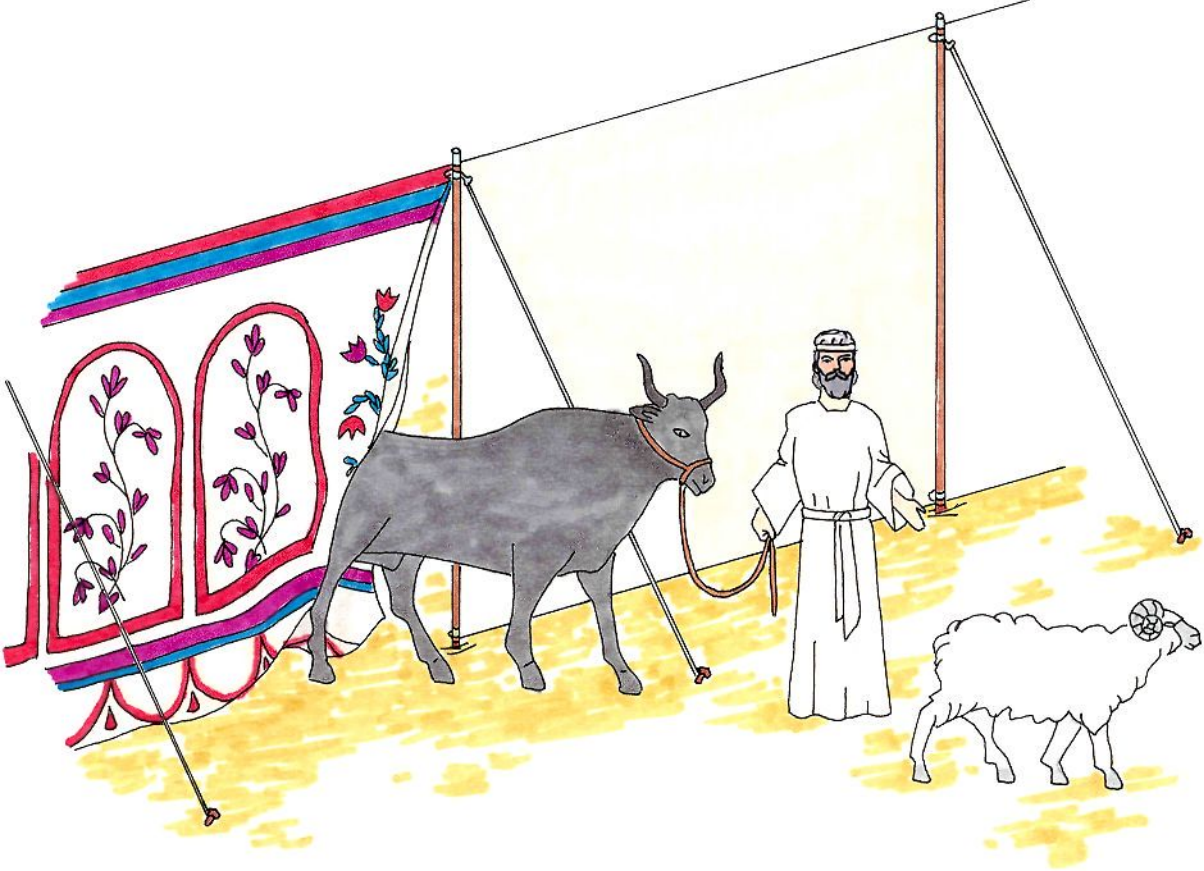









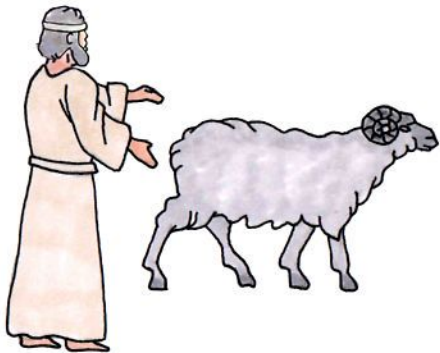









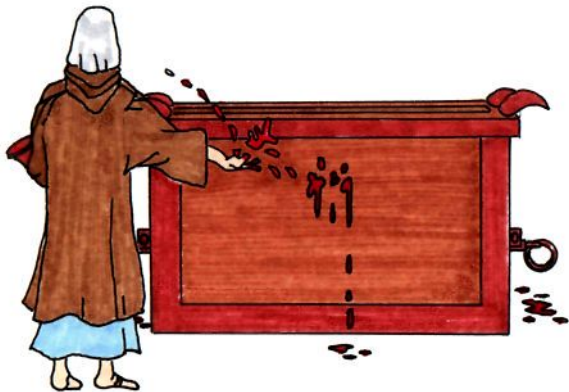



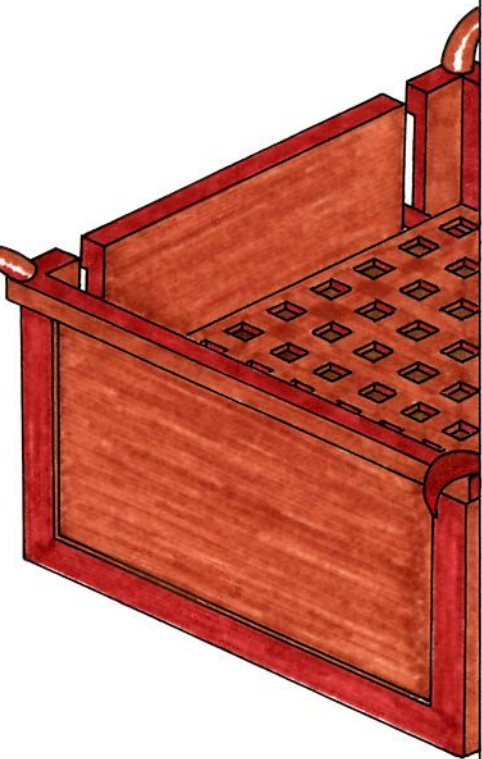

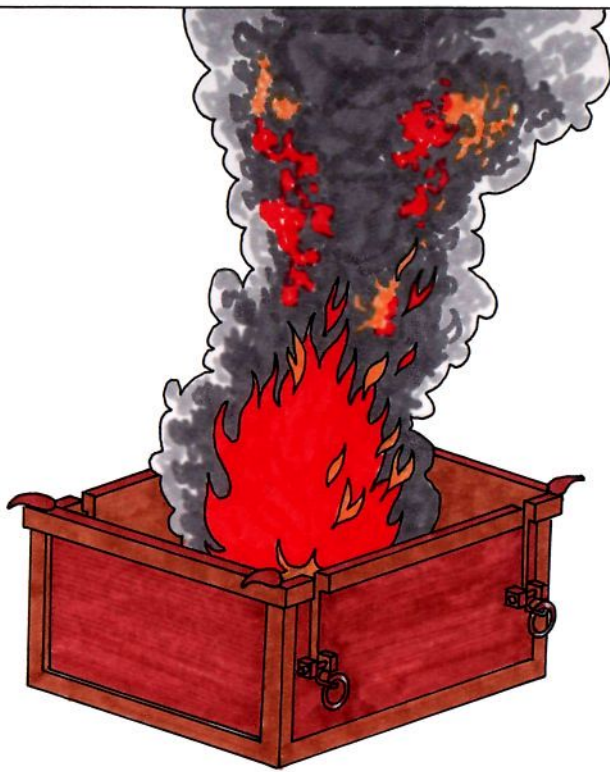



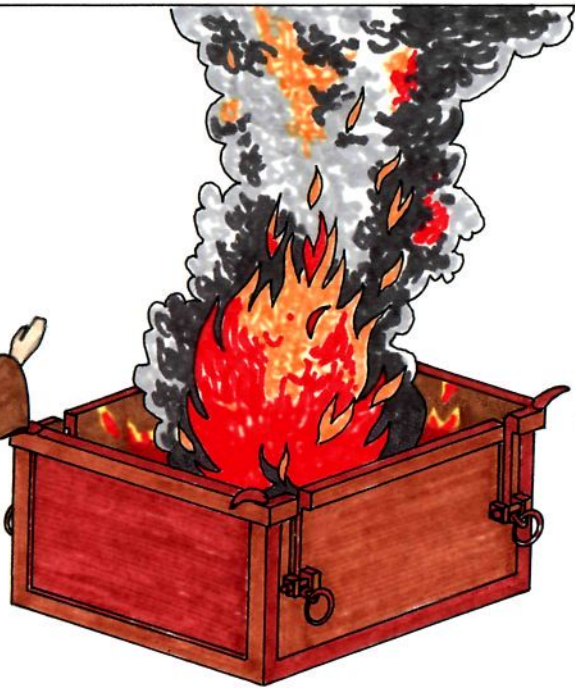



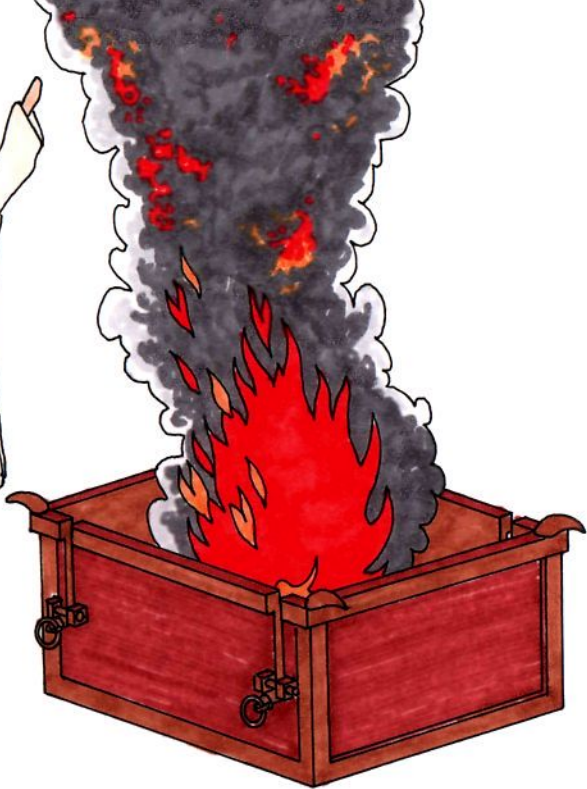

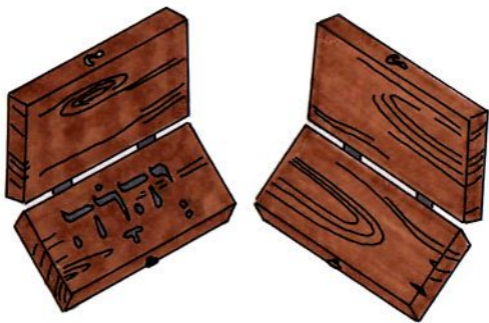

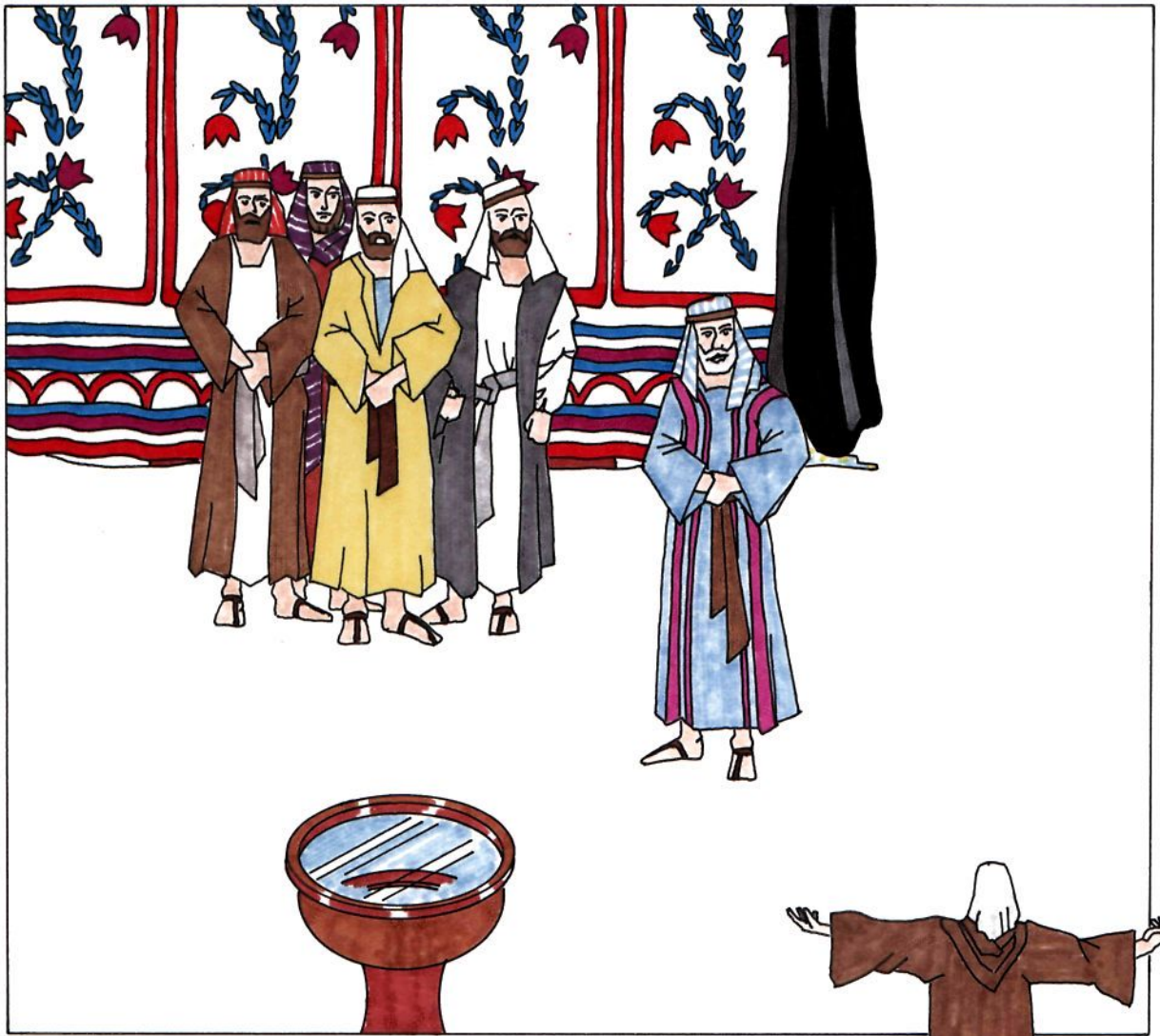

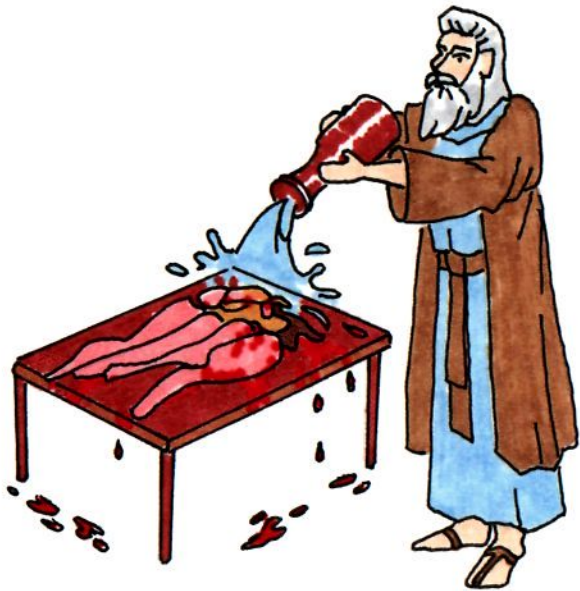



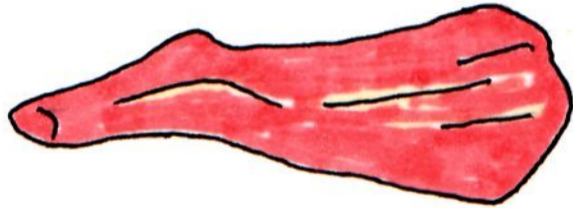



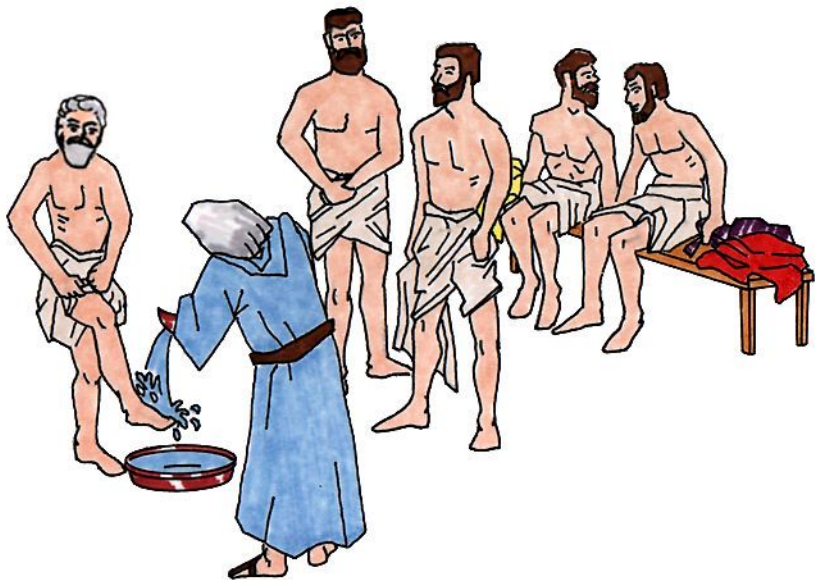









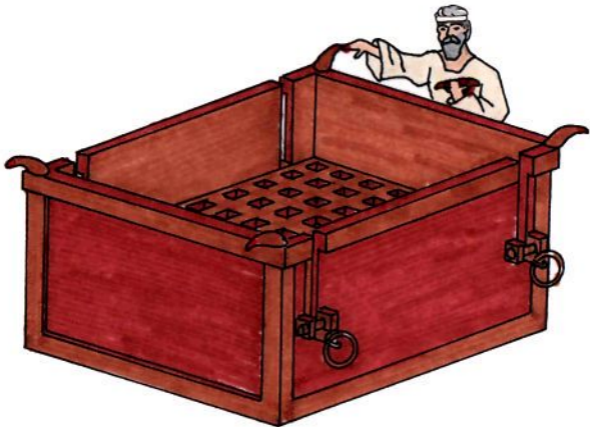



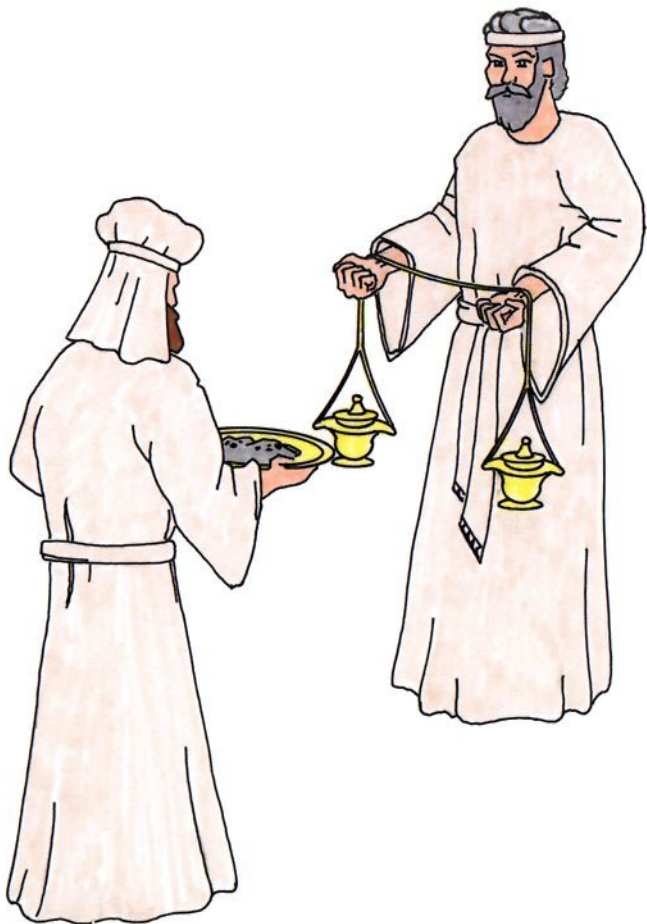







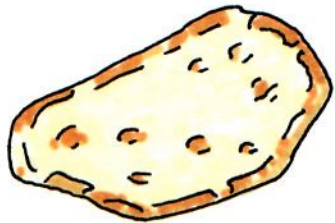





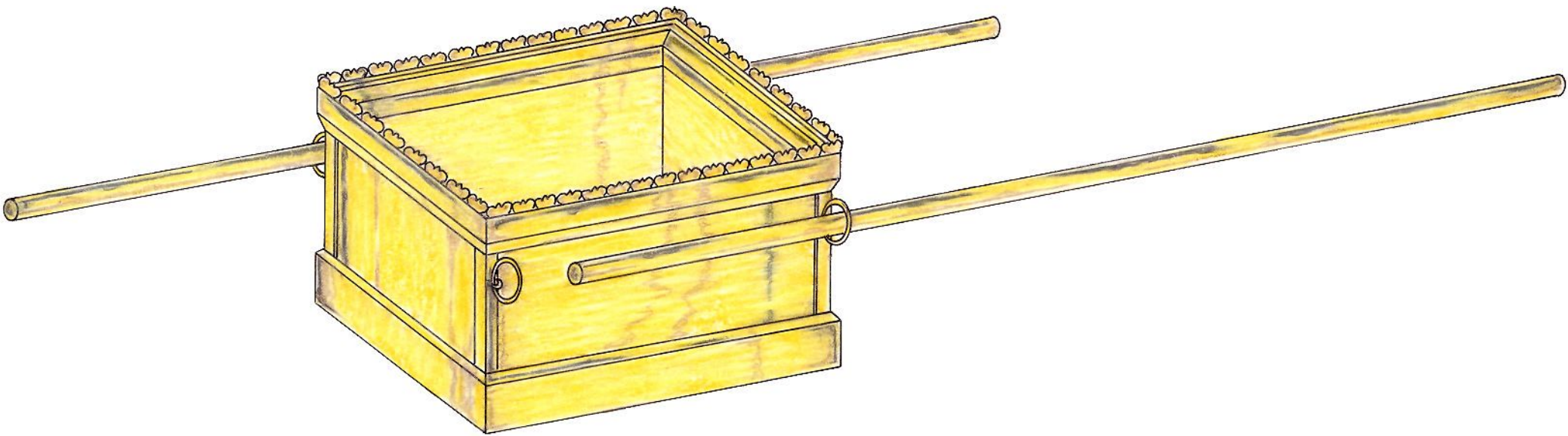

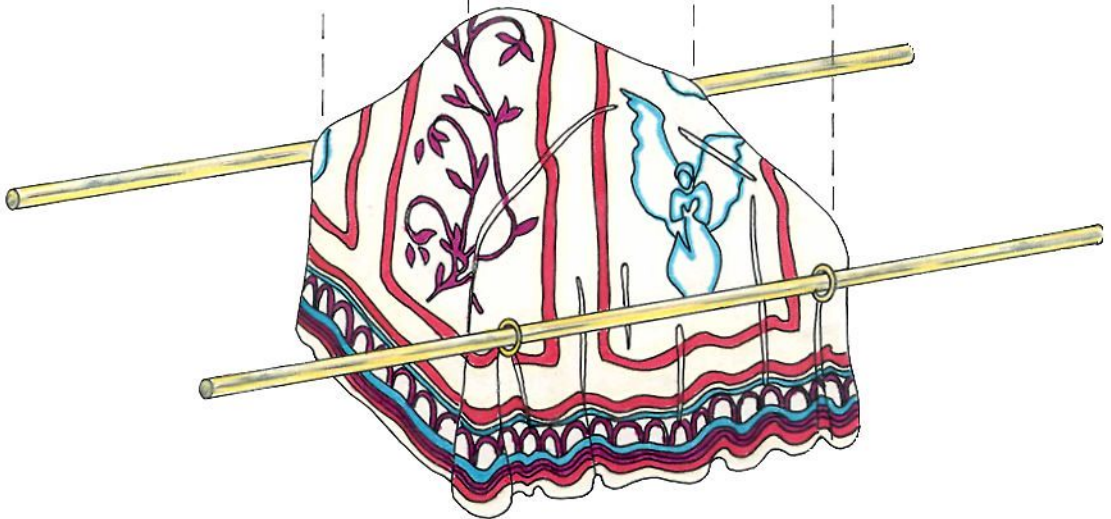
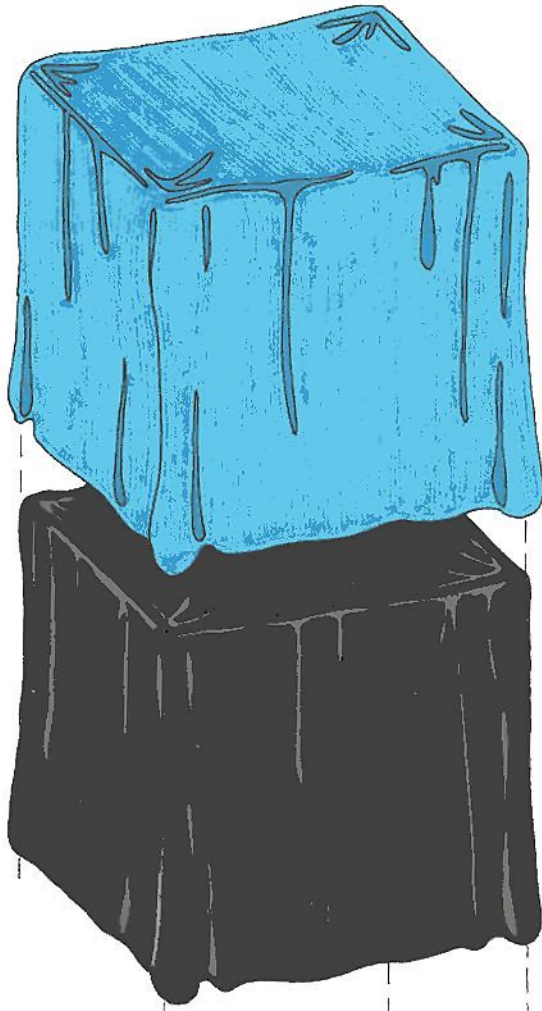

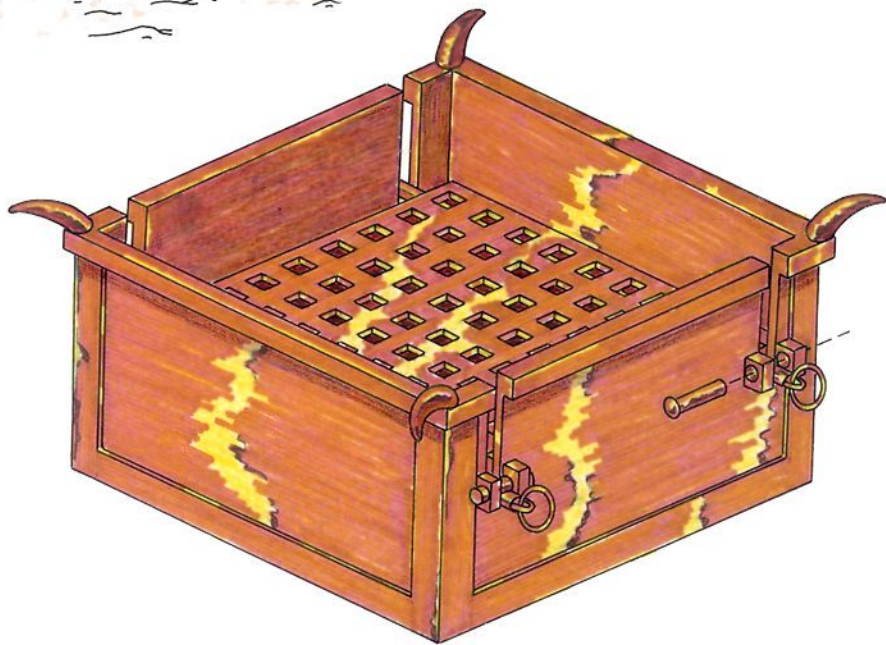
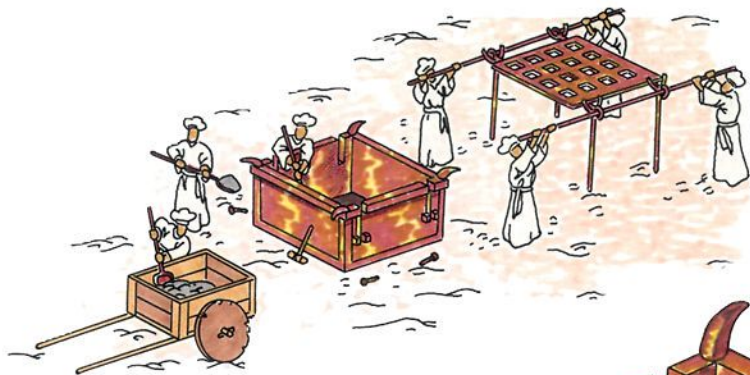

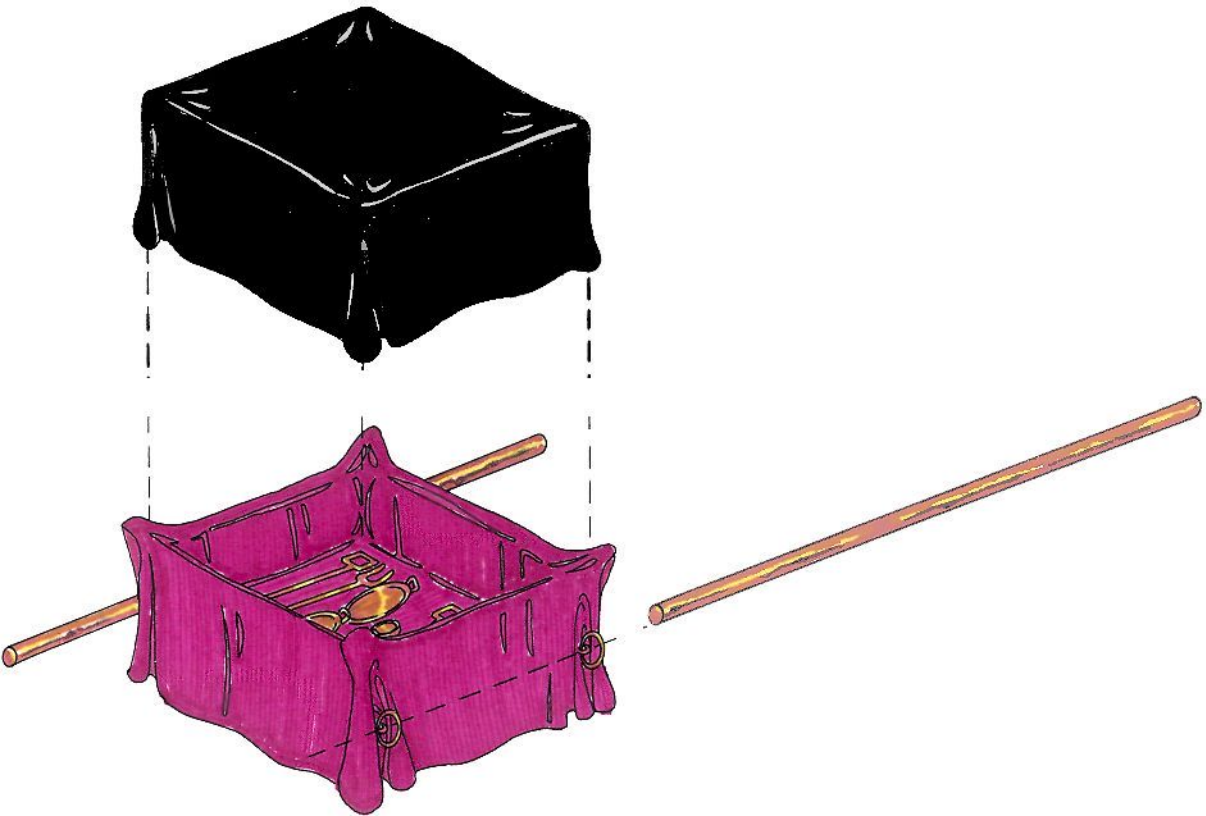

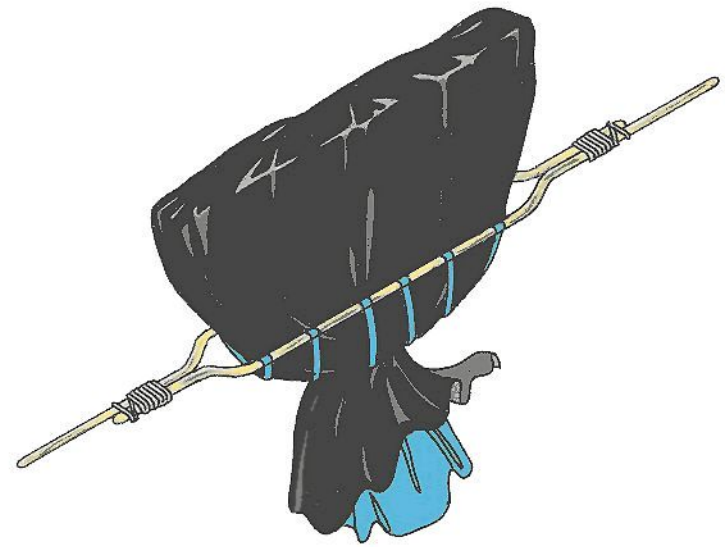
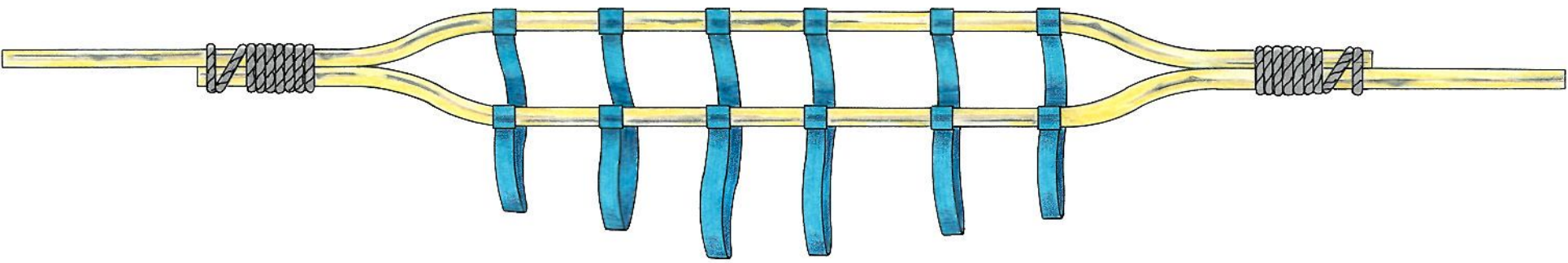





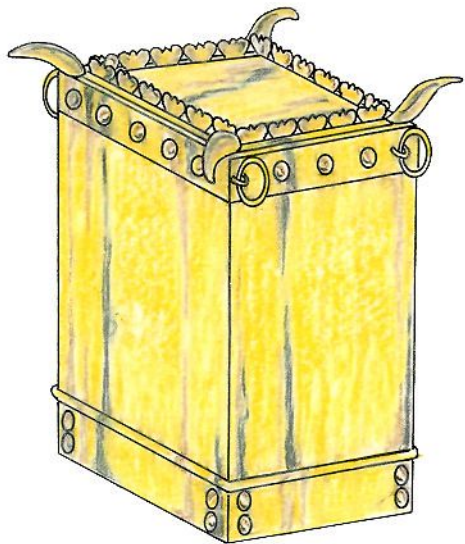

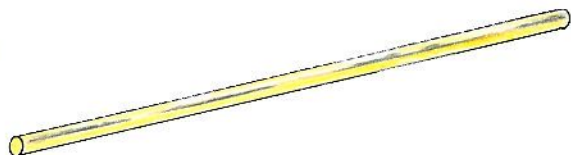
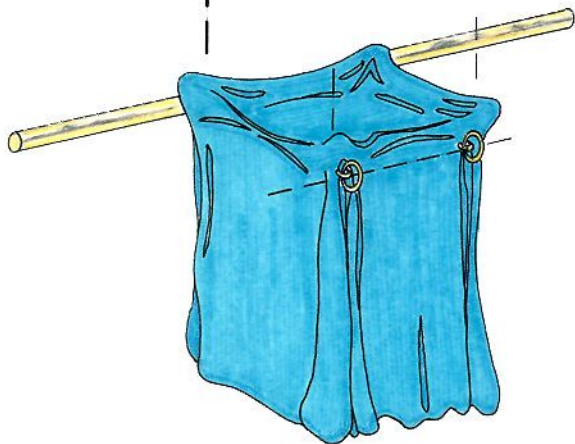
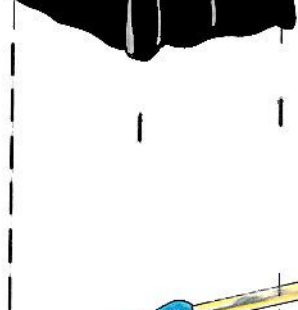





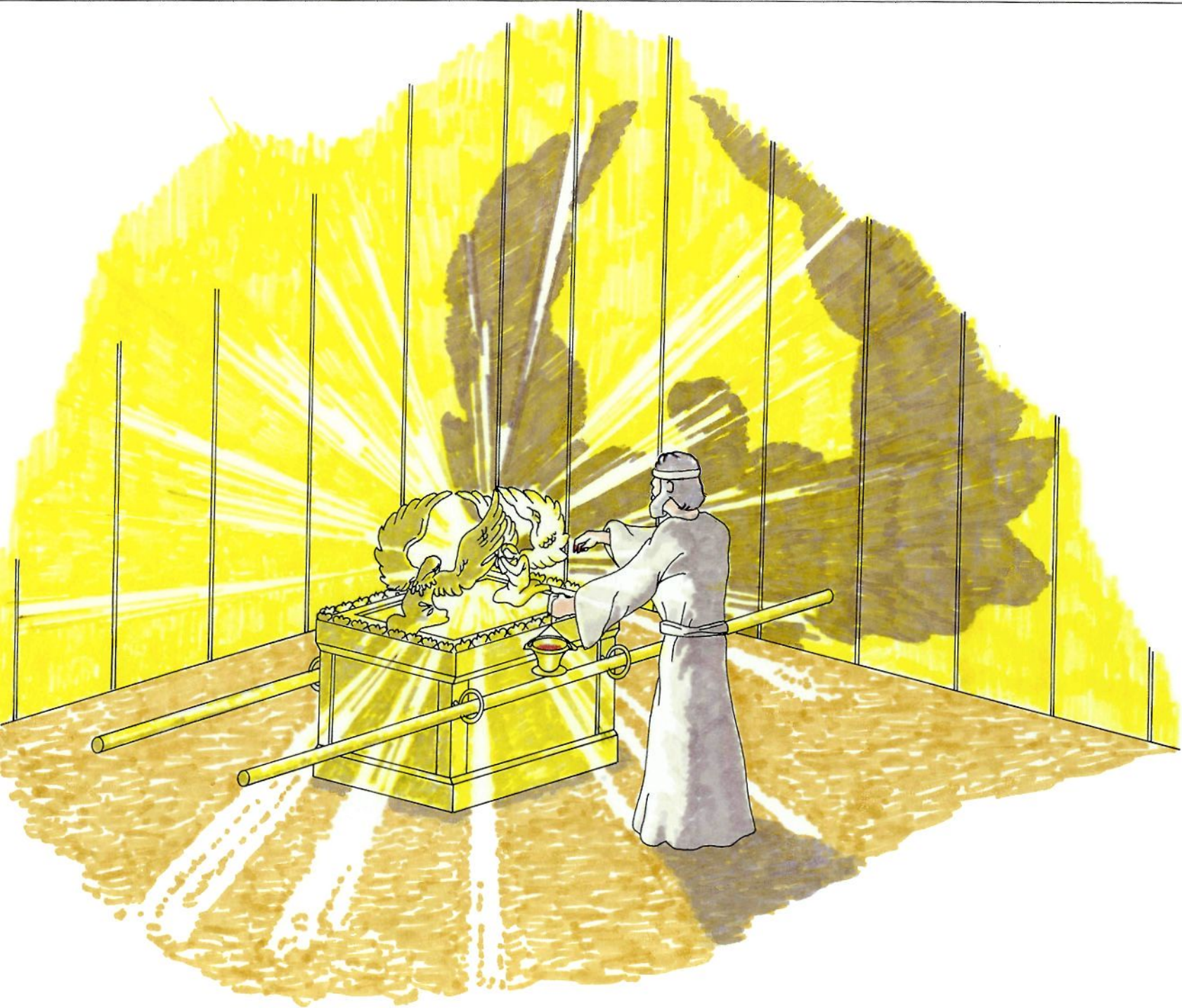

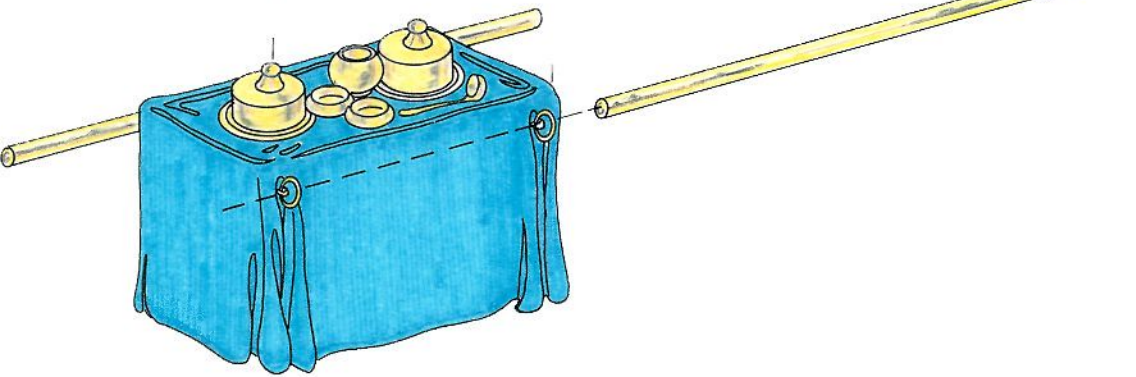
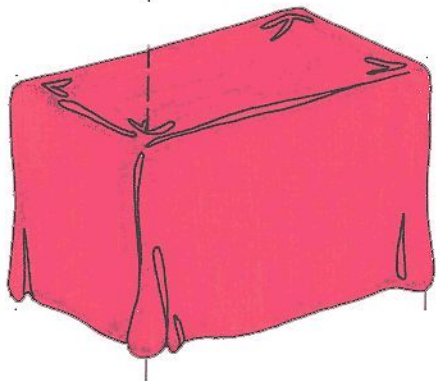
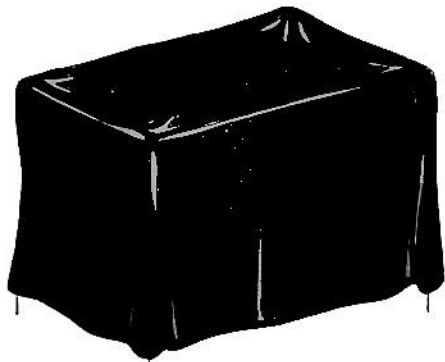

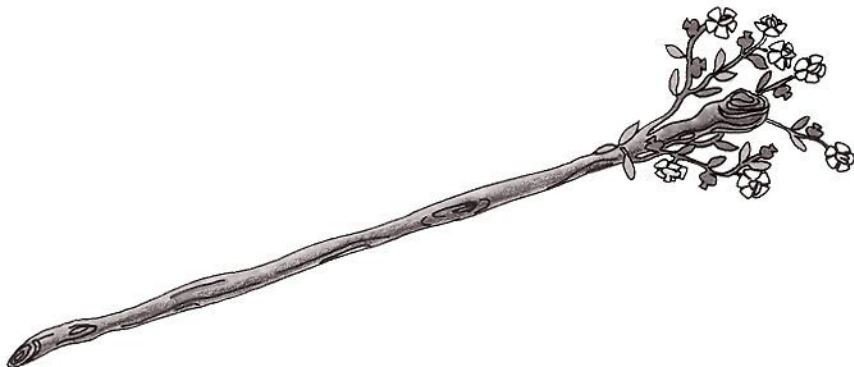



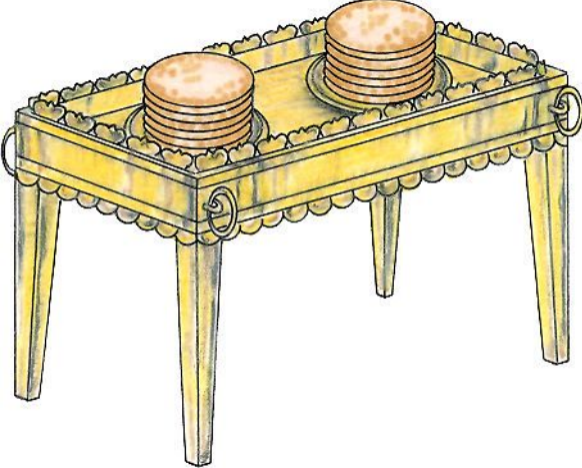







יבול

וְעֵשֶׂב־כֶּבֶד

וְהוֹרָה

נֶר

אֶבֶן

אֶפְסָיִם

כְּנִיָּמָן

אֶרְצָה

אֶפְסָיִם

נִפְתָּלִי

אֶרְצָה

אֶפְסָיִם







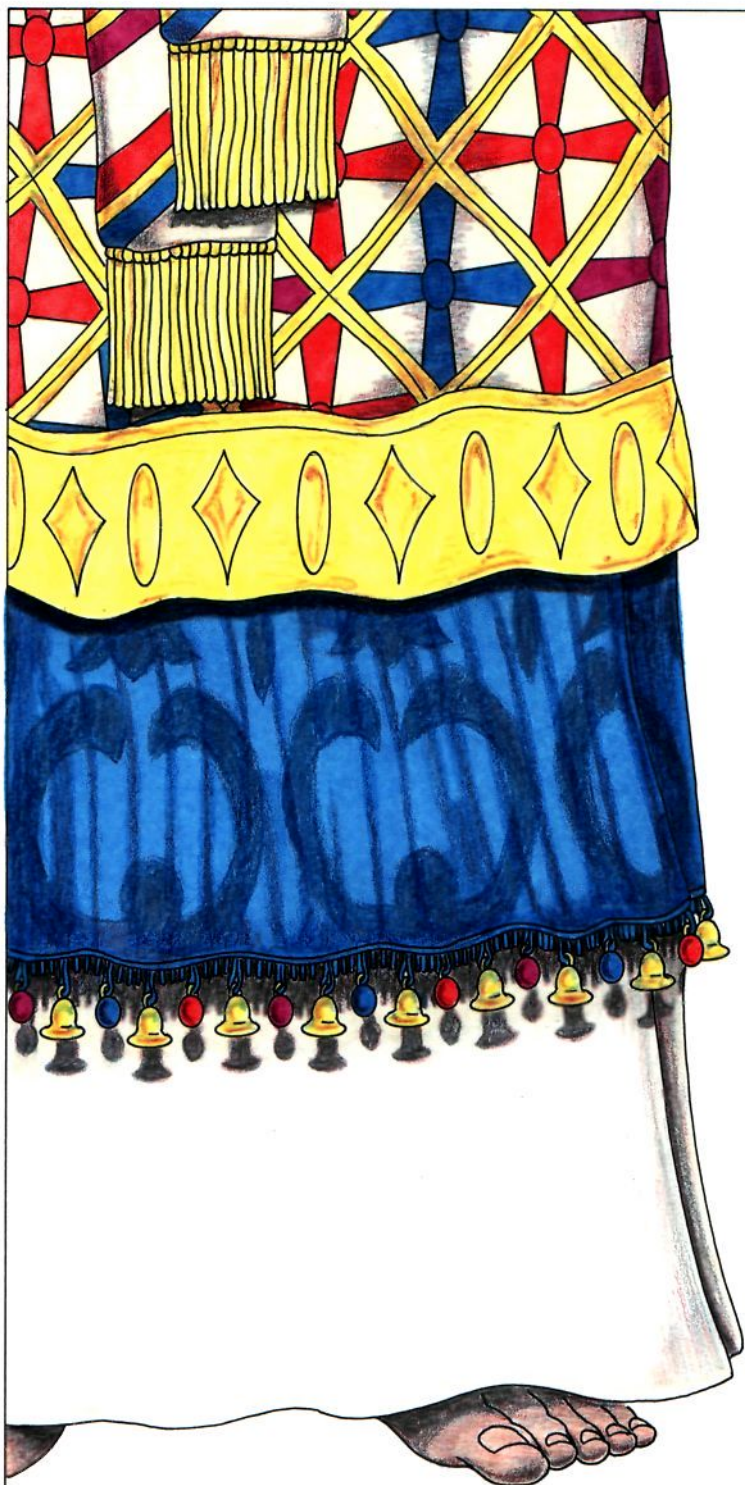



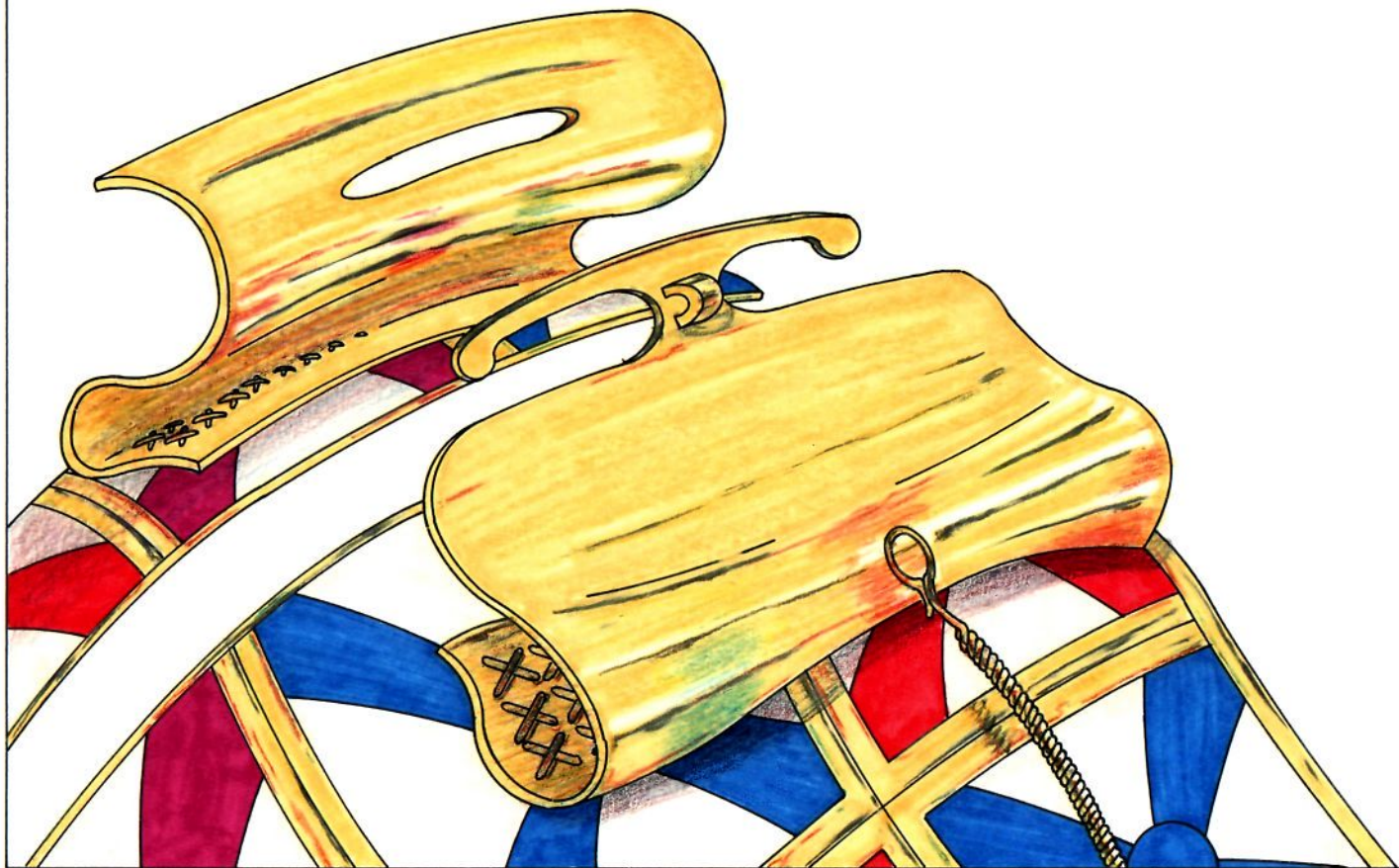









**The High Priest**



**The Under Priest**



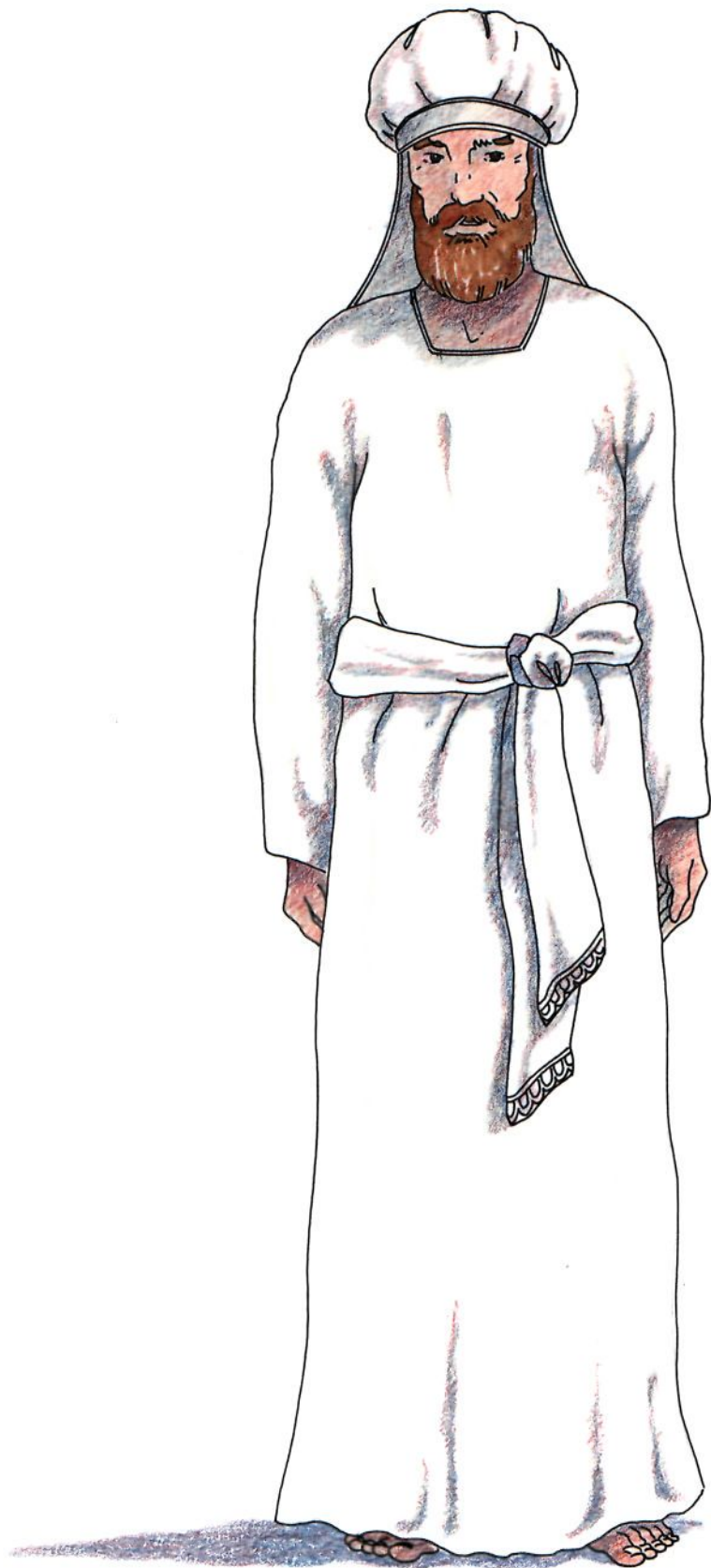





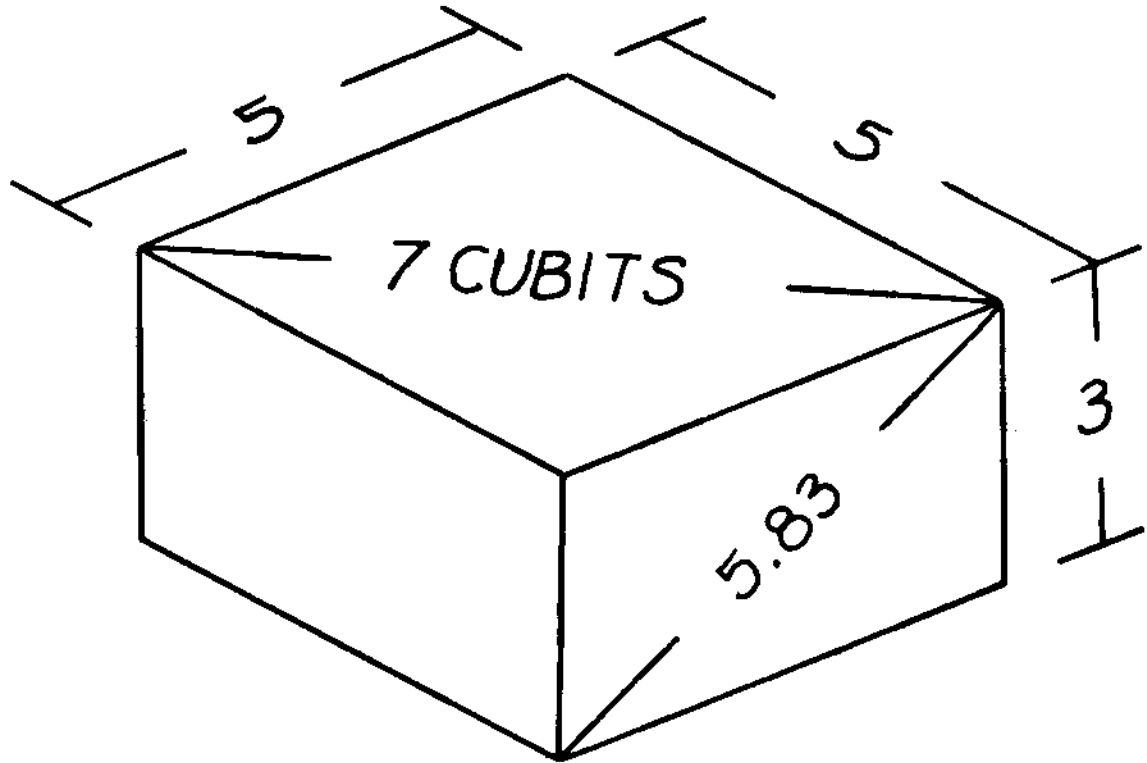

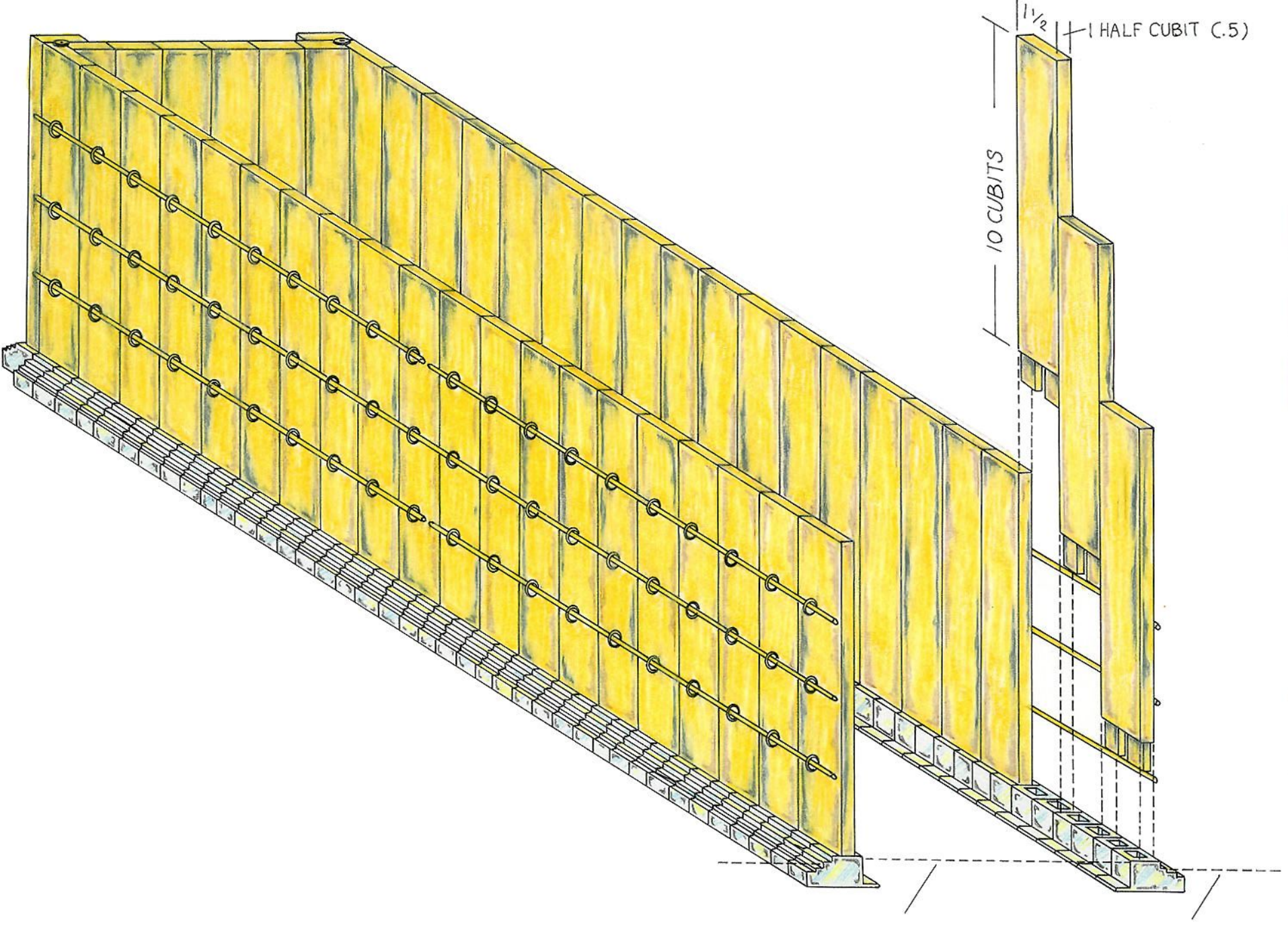

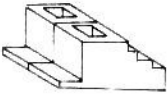

A — 10 CUBITS

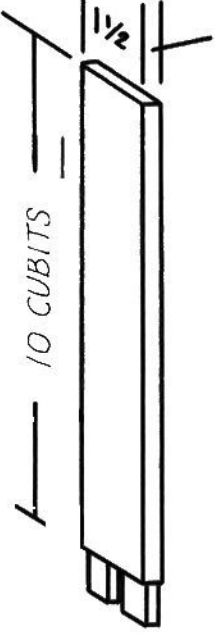

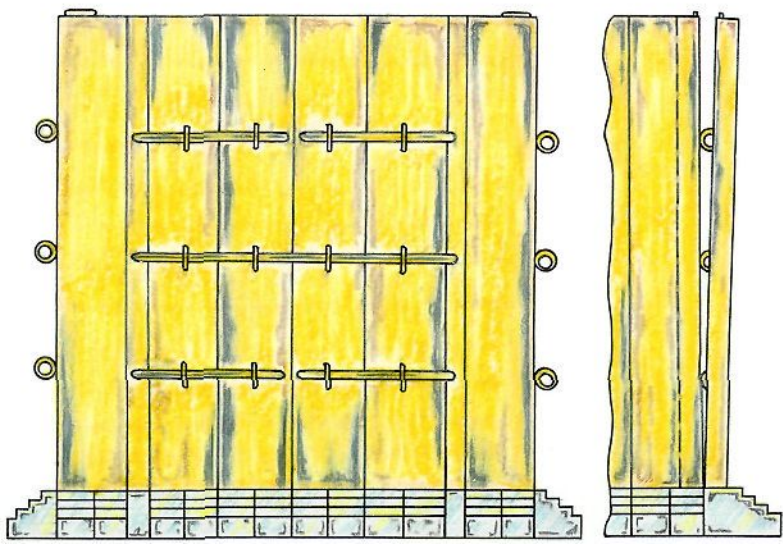
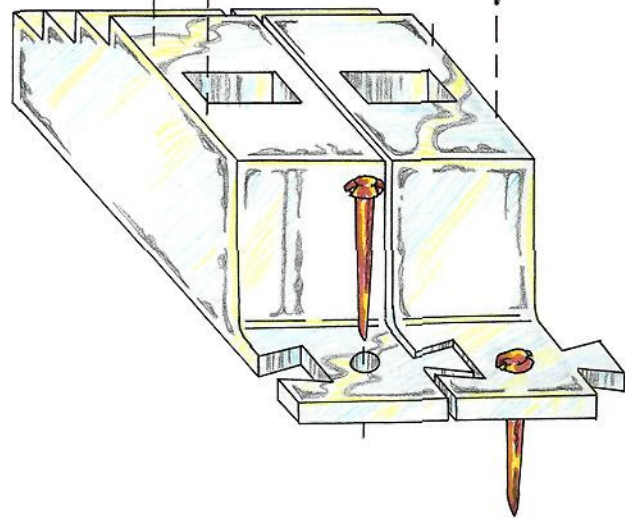
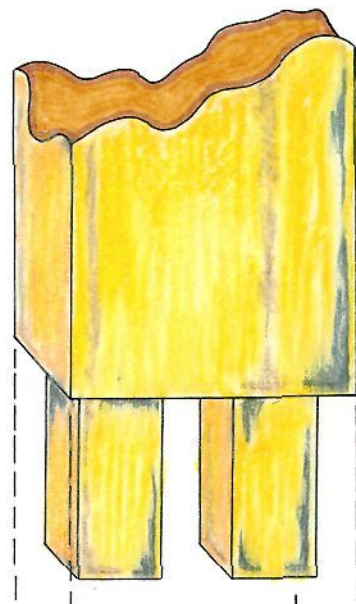
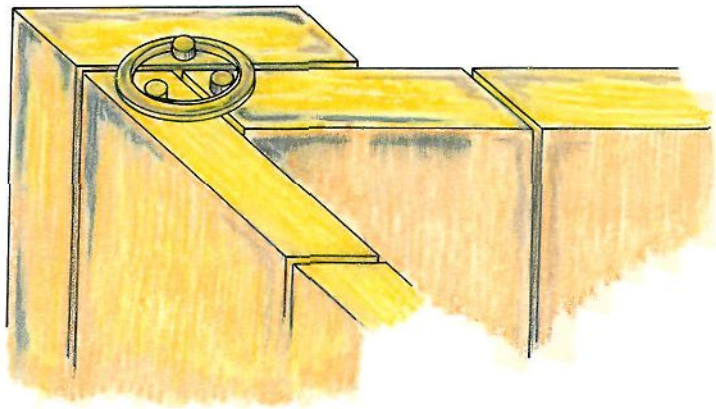

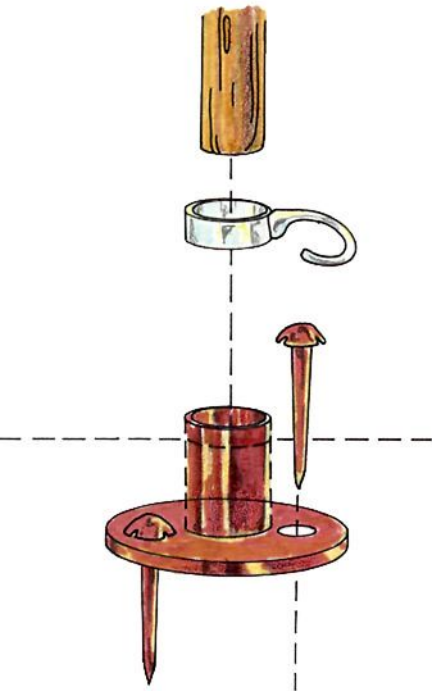

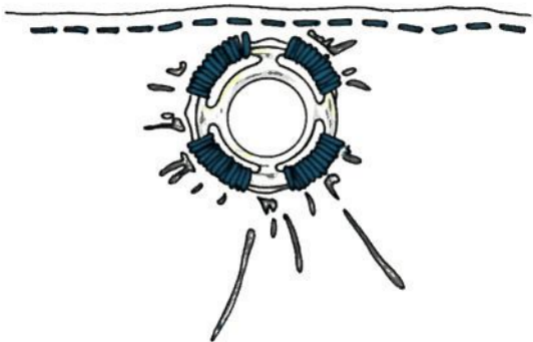







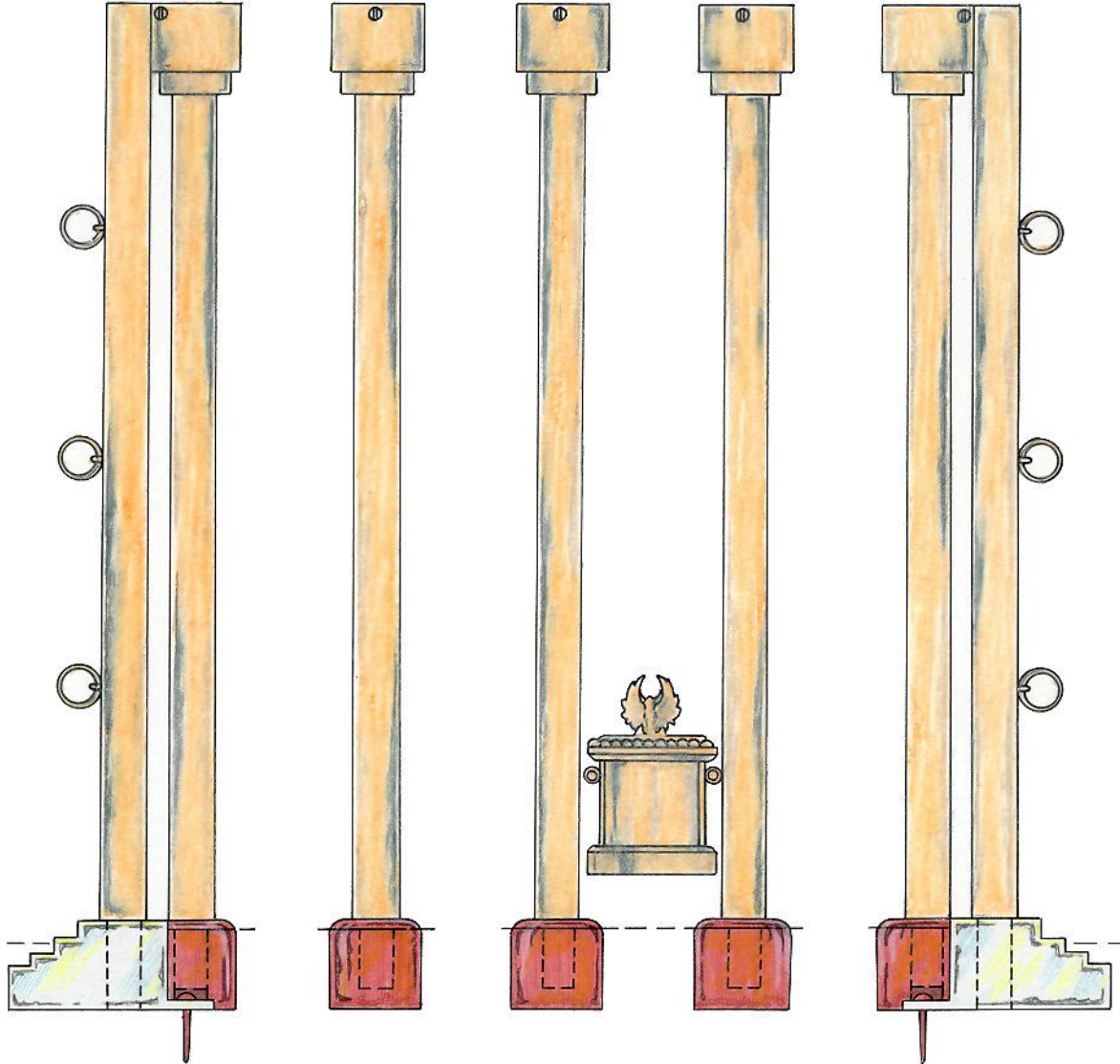

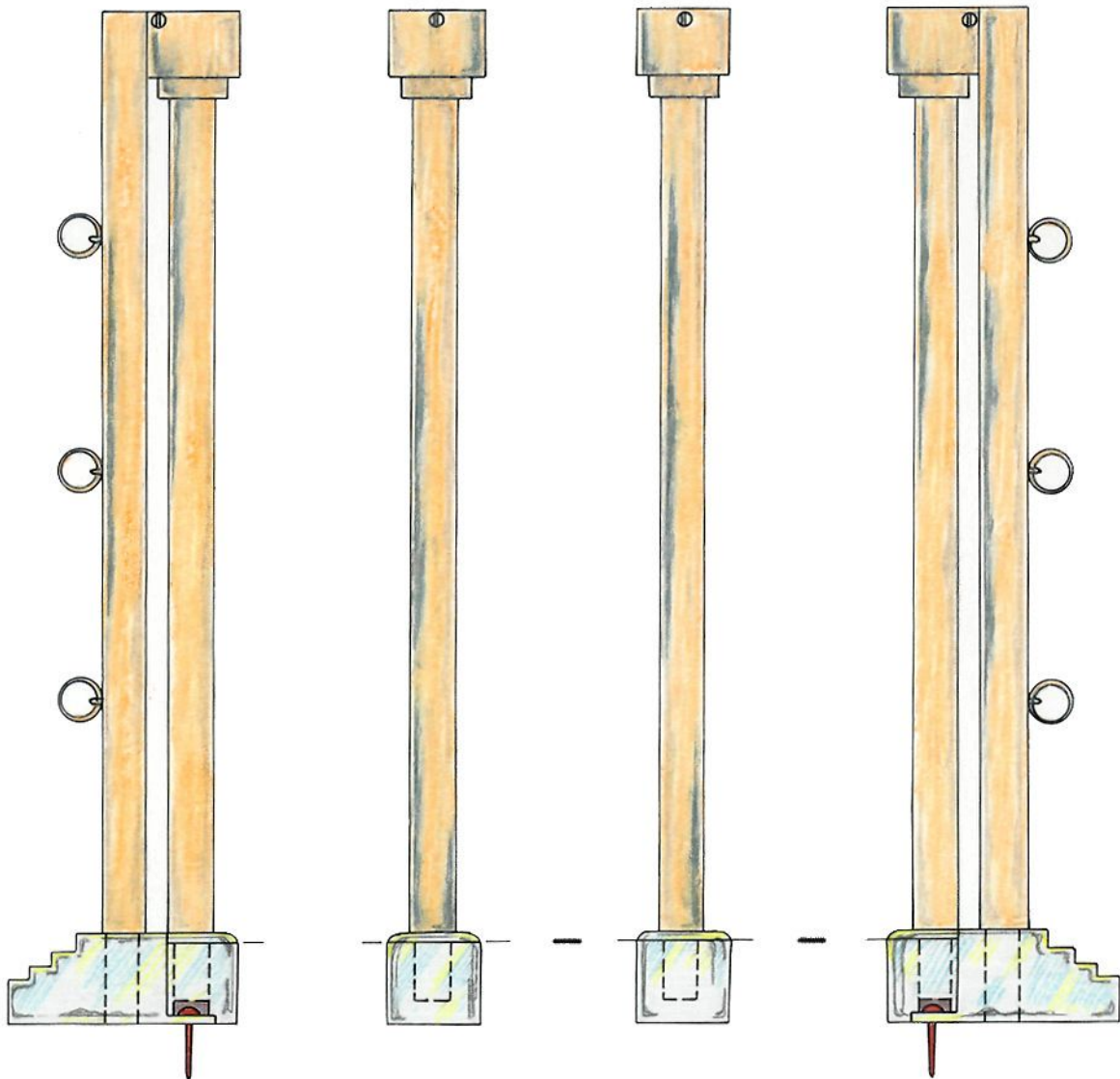

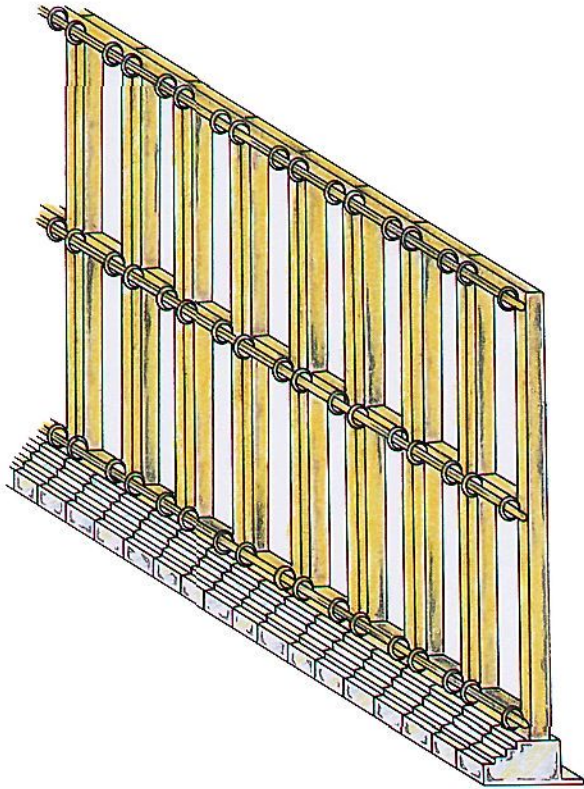

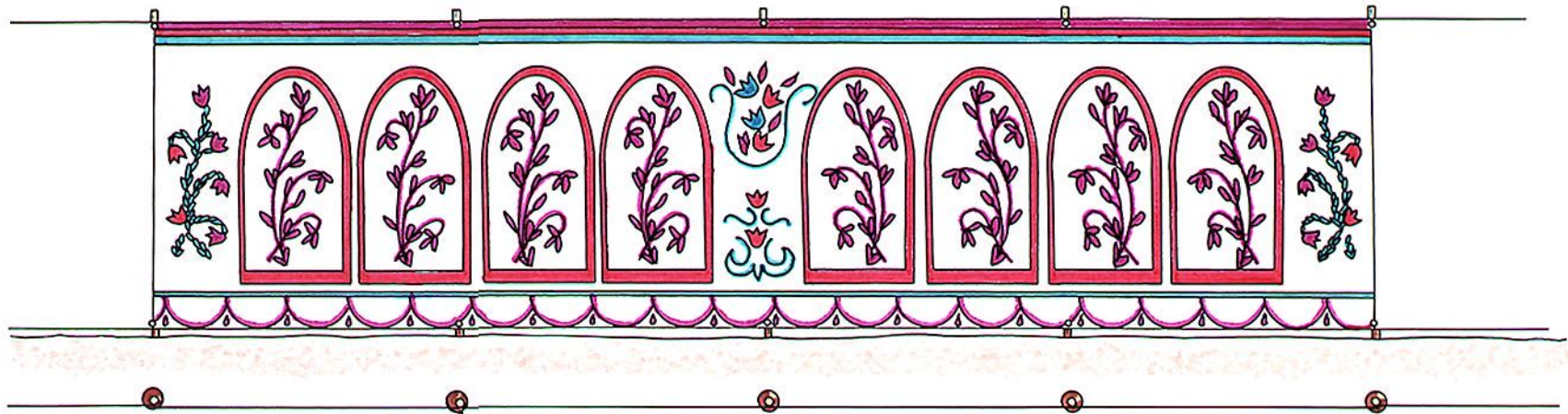



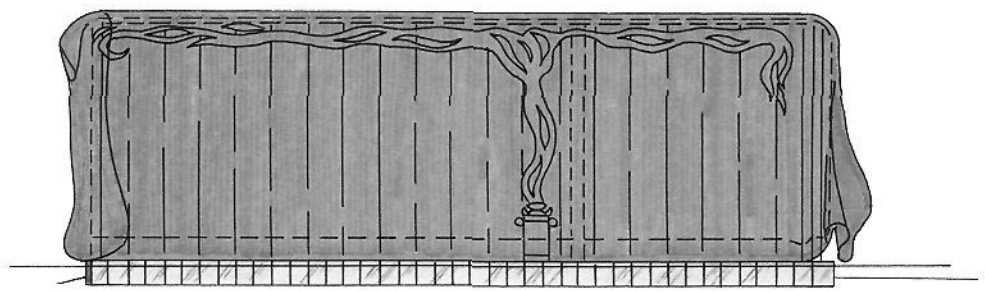
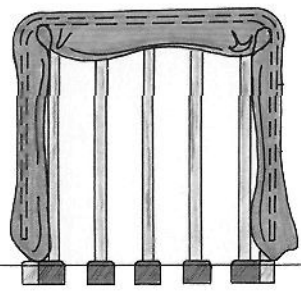
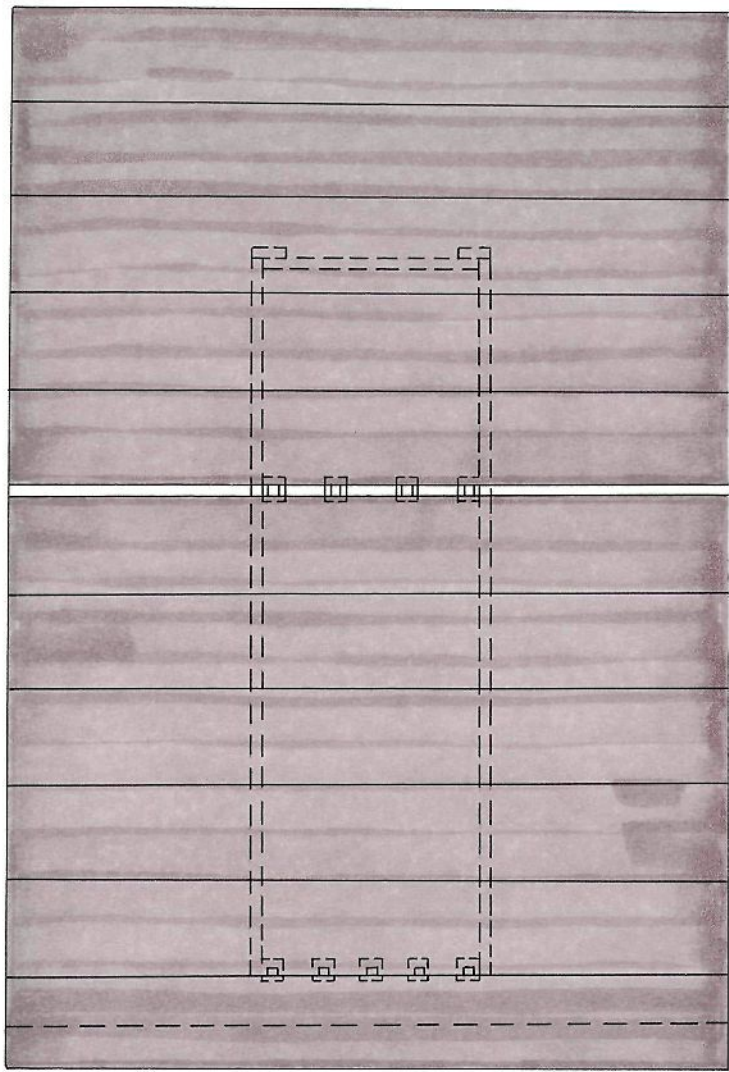

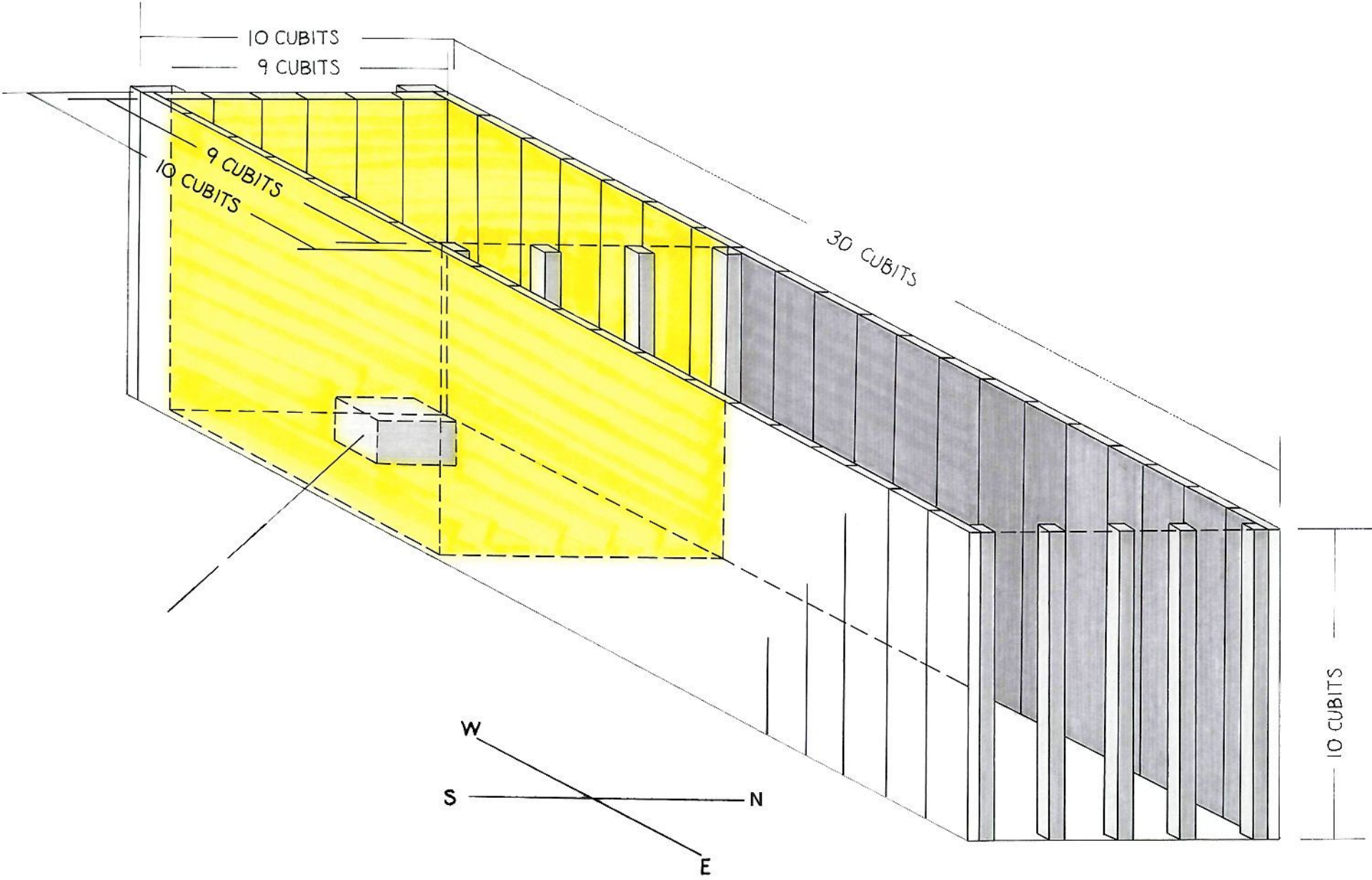

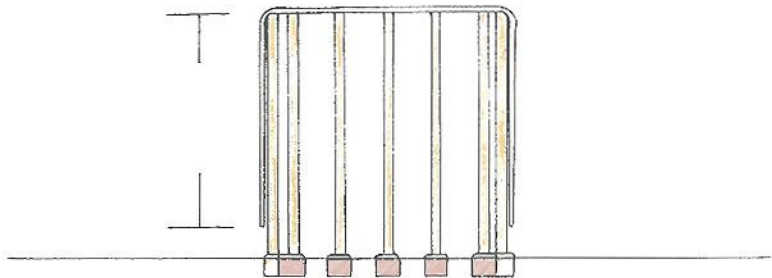
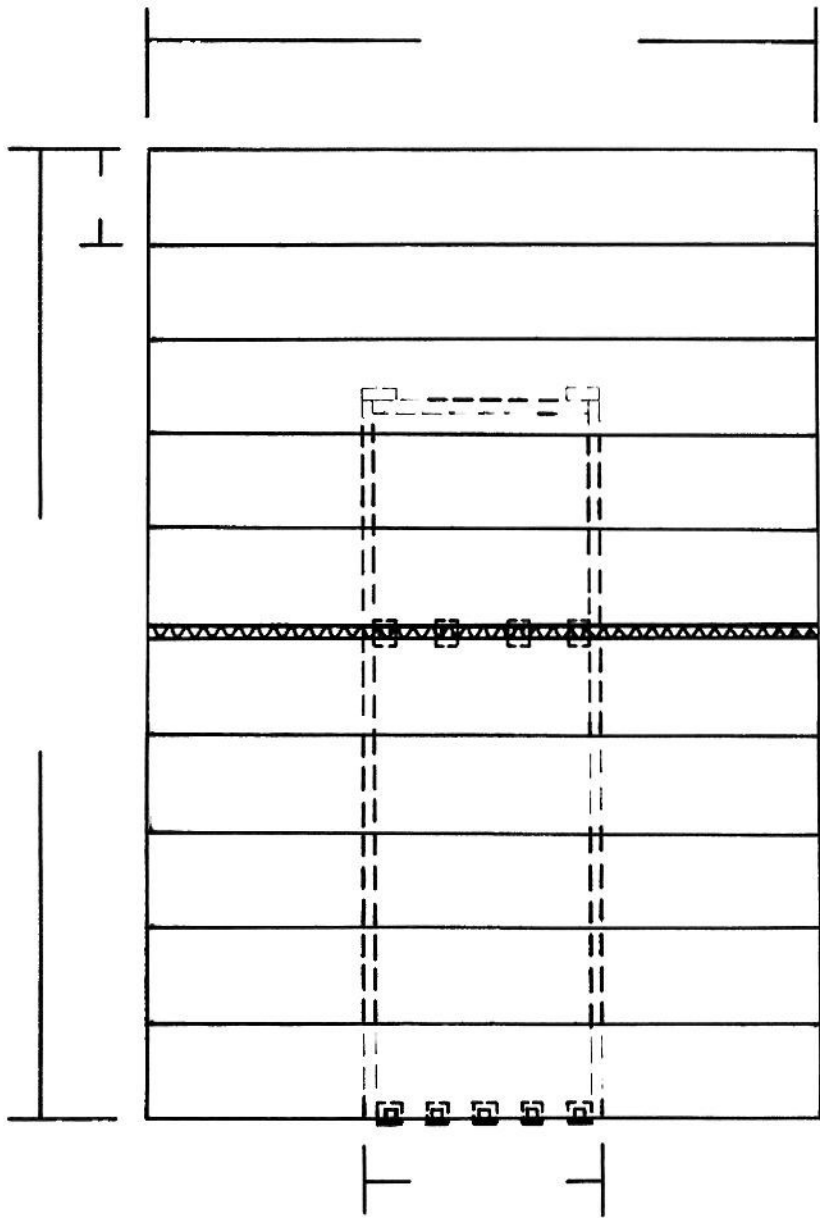



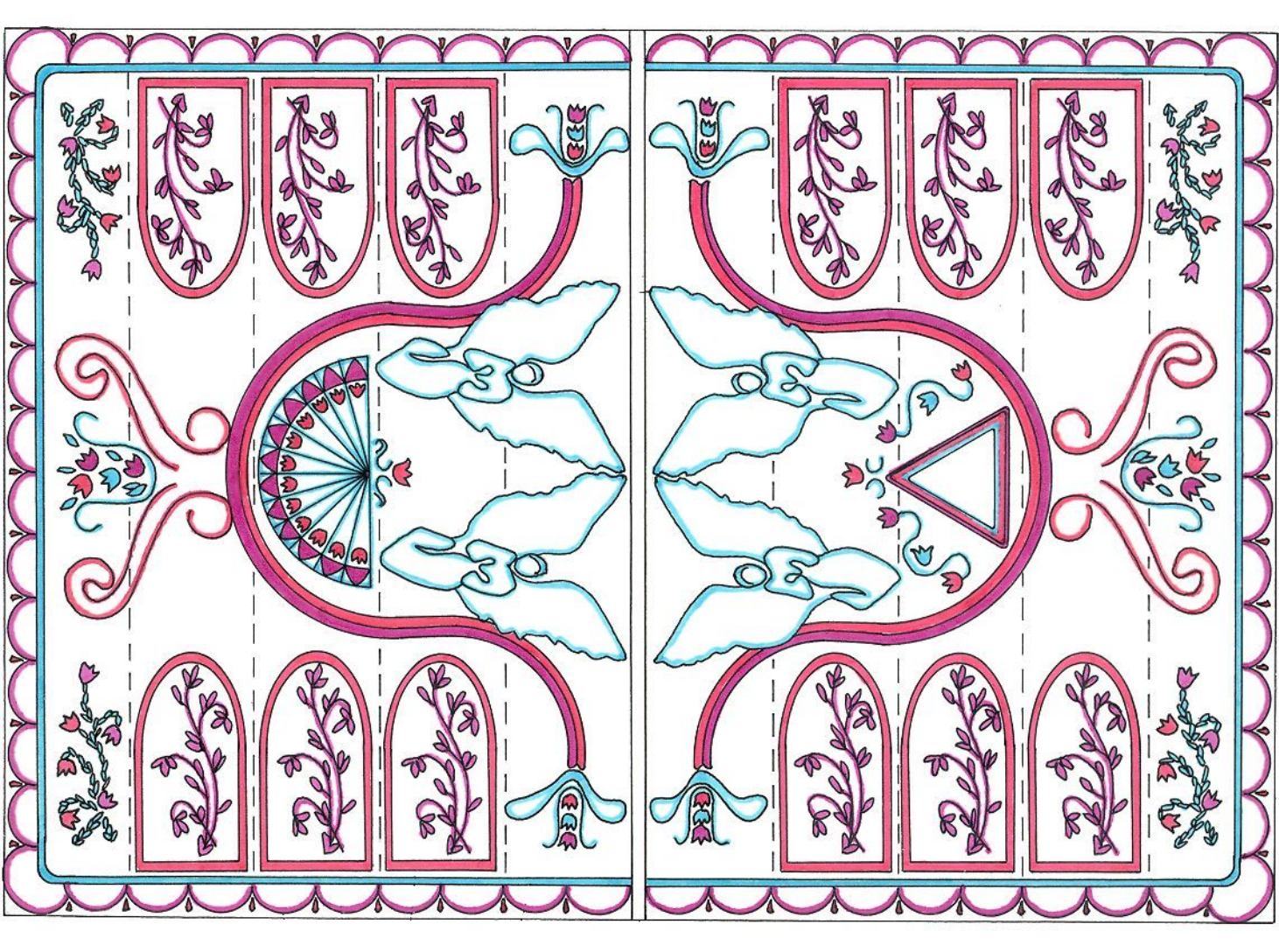

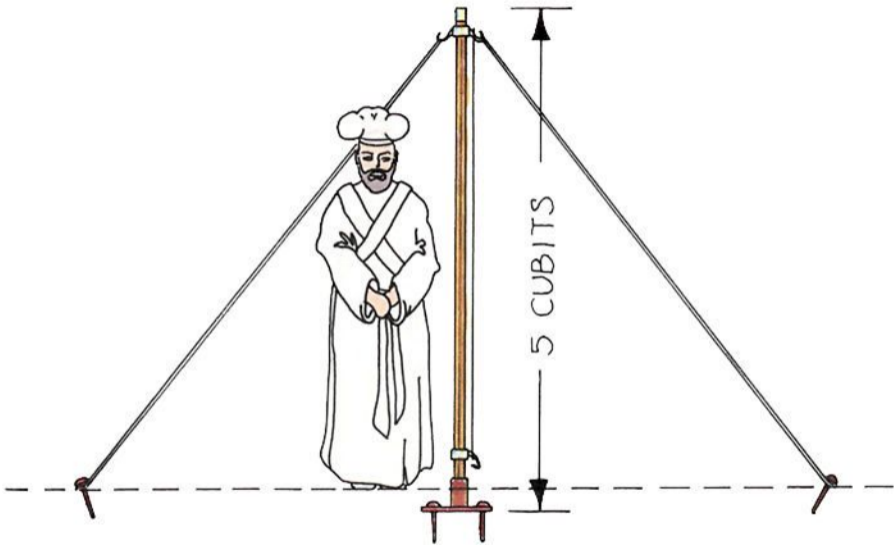

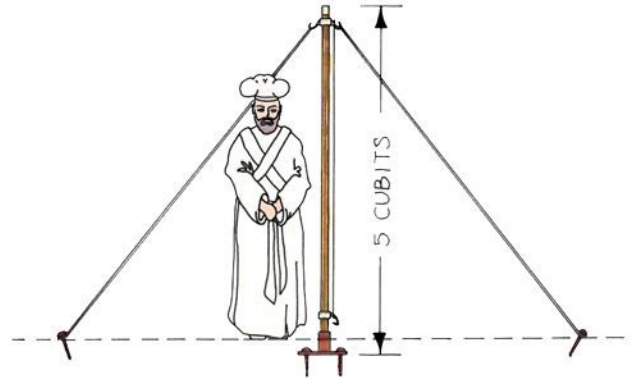
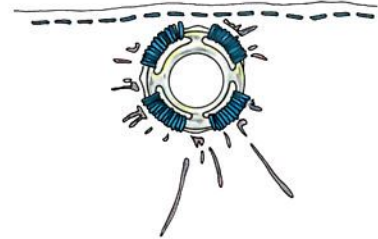
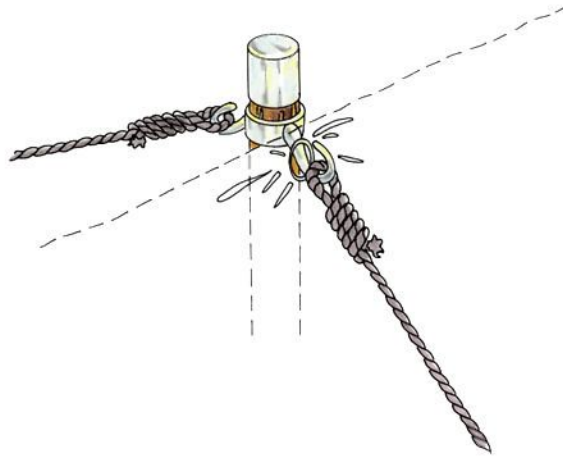
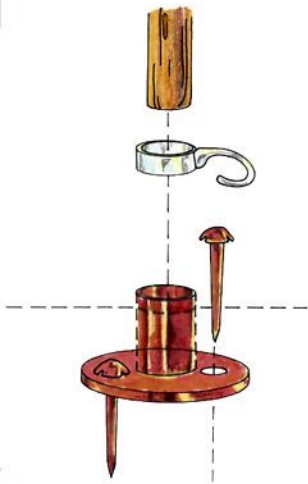

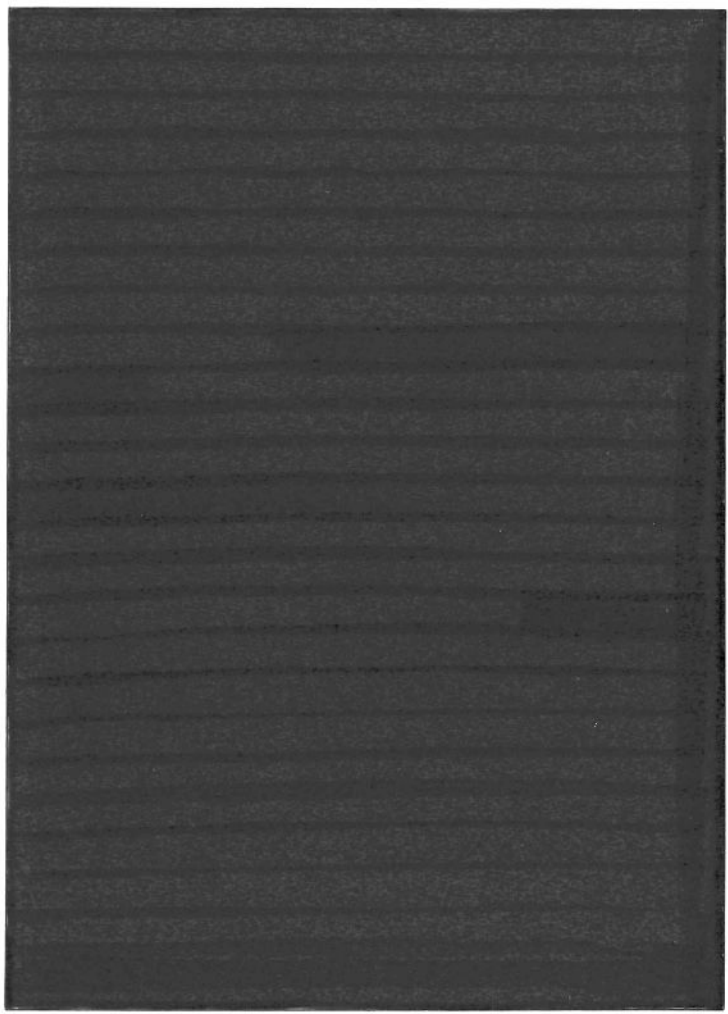
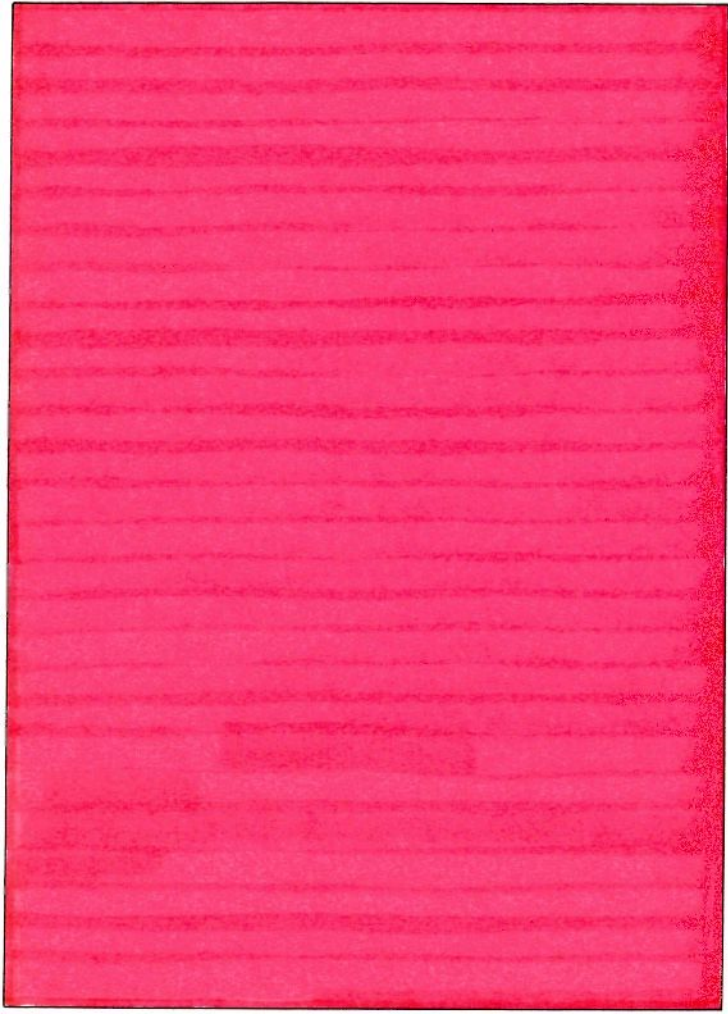

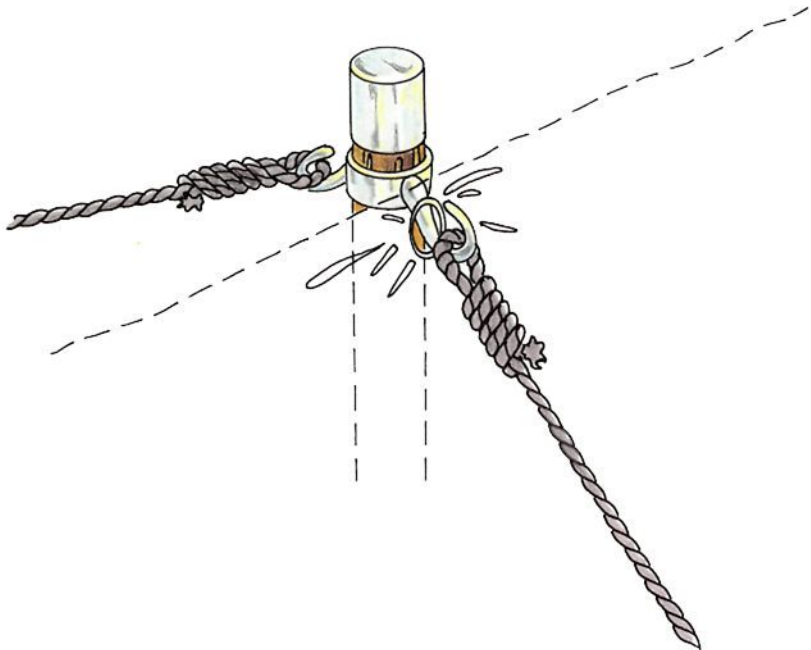

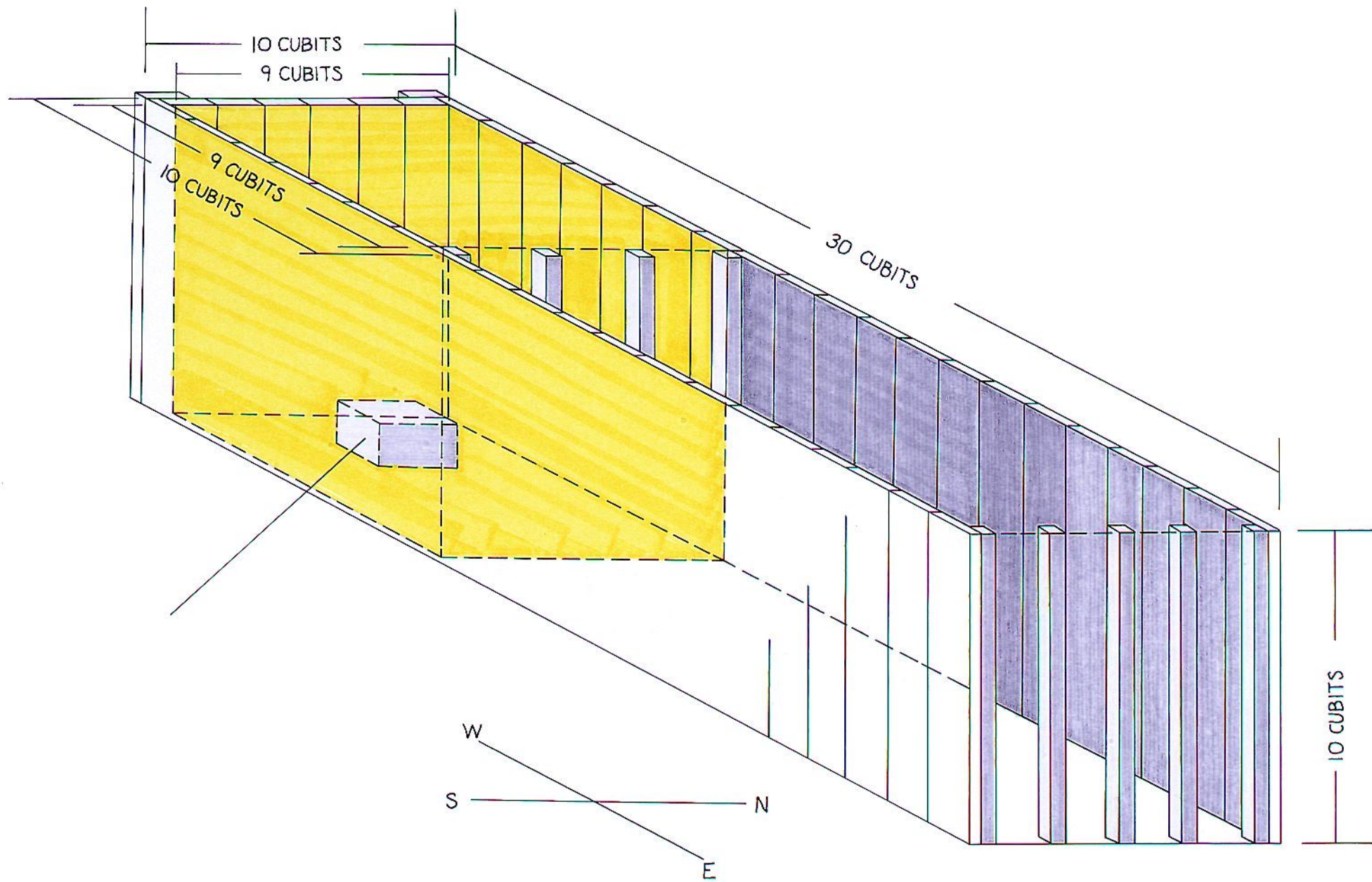

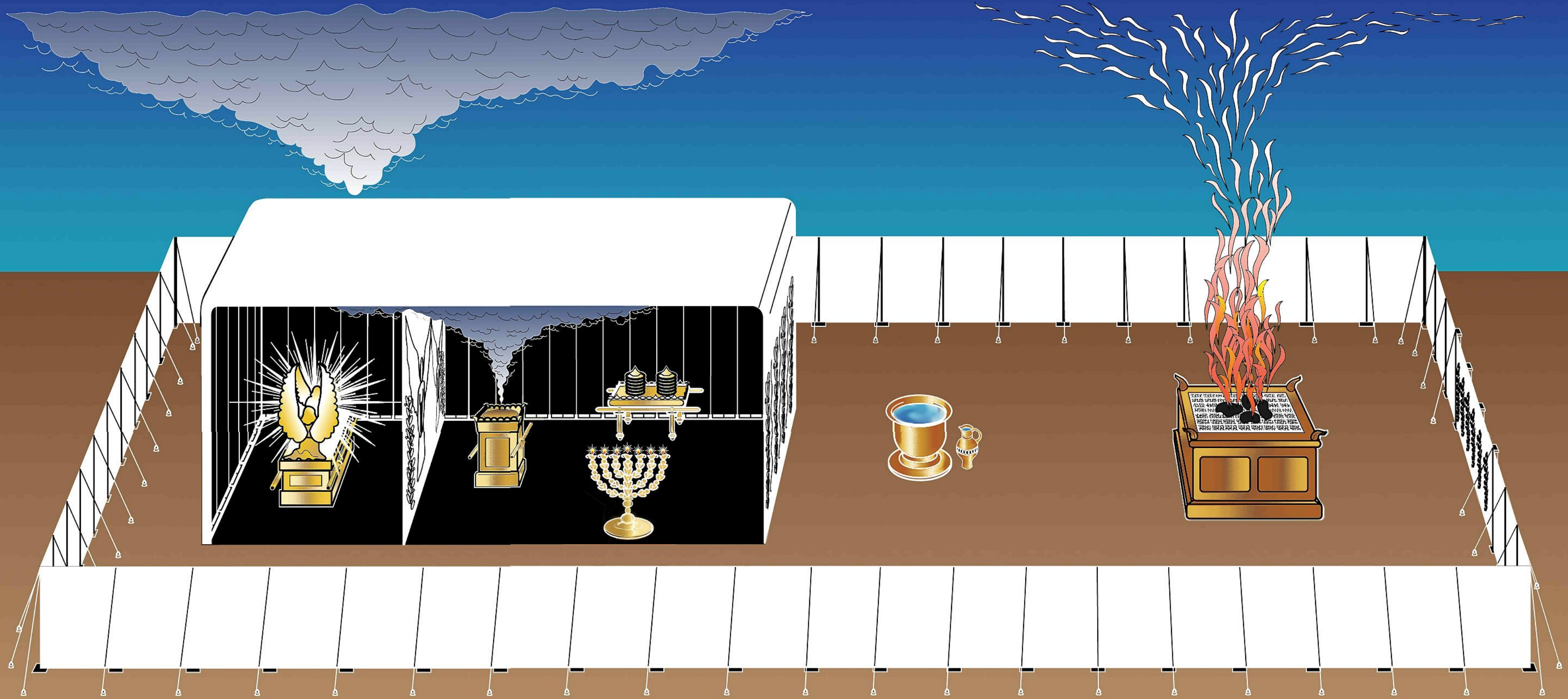

# THE TABERNACLE

